

JVC

ENGLISH

HARD DISK CAMCORDER

GZ-MG70E/EK

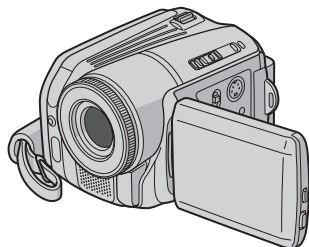

GETTING STARTED 7

VIDEO RECORDING & PLAYBACK 22

STILL IMAGE RECORDING & PLAYBACK 28

ADVANCED OPERATIONS 31

MENU SETTINGS 48

REFERENCES 52

To deactivate the demonstration, set "DEMO MODE" to "OFF".
(▶ pg. 48)

INSTRUCTIONS

LYT1495-001A

EN

Major Features of this Camera

Built-in Hard Disk

This hard disk camera records images to a large, built-in hard disk drive (HDD) instead of a DV tape like conventional video cameras. This enables extended hours of high-resolution, MPEG2 video recording.

Various Recording Modes

You can select the most suitable recording mode for picture quality, image size, recording time, and computer environment. (☞ pg. 62)

Enjoying Various Playback Features

Unlike tape operation, playback is simple and easy in this camera since no time is needed for rewinding or fast forward operations.

Playlist, playback effects, and other functions are also available for enjoying many different types of playback.



Editing Files on your PC

USB 2.0 enables the smooth transfer of video and still images to a computer. With the bundled image editing software, you can easily edit video and create your own DVDs. (Refer to "Read this first!" and the software installation and USB connection guide.)



Flash

You can record still images in dark places more easily. The flash fires automatically during still image recording. (☞ pg. 31)

Direct Printing

If your printer is compatible with PictBridge, still images can be printed easily by connecting the camera with USB cable directly to the printer. (☞ pg. 47)

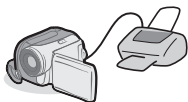

Contents

GETTING STARTED 7

Provided Accessories	7
Index	10
Power	14
Operation Mode	16
Language Setting	17
Date/Time Settings	18
Brightness Adjustment of the Display	18
Grip Adjustment	19
Tripod Mounting	19
Inserting/Removing an SD Card	19
Formatting a Recording Medium	20
Selecting a Recording Medium	21
Remaining Space on the Recording Media	21
Drop Detection	21

VIDEO RECORDING & PLAYBACK 22

Video Recording	22
Zooming	23
Video Playback	24
How to Use the Scroll Bar	25
Date Index Screen	25
Various Playback Operations	25
Playback Zoom	25
Connecting to a TV, VCR or DVD Recorder	26
Playback on a TV	26
Dubbing to a VCR (or DVD Recorder)	26
Playback Using the Remote Control	27

STILL IMAGE RECORDING & PLAYBACK 28

Still Image Recording	28
Zooming	28
Continuous Shooting	28
Still Image Playback	29
Slide Show	29
Index Screen of Still Image Files	29
How to Use the Scroll Bar	30
Date Index Screen	30
Image Rotation	30
Playback Zoom	30

ADVANCED OPERATIONS 31

RECORDING FEATURES 31

Backlight Compensation	31
Spot Exposure Control	31
Flash	31
Manual Settings in MSET Menu	32
How to Select a Menu Item	32
Manual Exposure	32
Manual Focus	33
White Balance	34
Shutter Speed	35
Program AE	36
Effect	36

PLAYBACK FEATURES 37

Wipe or Fader Effects	37
Playback Effects	37

MANAGING FILES 38

Viewing File Information	38
Protecting Files	38
Deleting Files	39
Cleaning Up a Recording Medium	40
Copying/Moving Still Image Files	41
Resetting the File Number	42
Creating Play List	42
Playing Back Play List	43
DPOF Print Setting	46
Direct Printing with a PictBridge Printer	47

MENU SETTINGS 48

Changing the Menu Settings	48
Common Menus for All Modes	48
Video Recording Menus	50
Video Playback Menus	50
Still Image Recording Menus	51
Still Image Playback Menus	51

REFERENCES 52

Troubleshooting	52
Warning Indications	55
Cleaning the Camera	57
Cautions	57
Specifications	60

TERMS Back cover

Dear Customer,

Thank you for purchasing this hard disk camera. Before use, please read the safety information and precautions contained in the pages 4 – 6 to ensure safe use of this product.

SAFETY PRECAUTIONS**IMPORTANT (for owners in the U.K.)
Connection to the mains supply in the United Kingdom.****DO NOT cut off the mains plug from this equipment.**

If the plug fitted is not suitable for the power points in your home or the cable is too short to reach a power point, then obtain an appropriate safety approved extension lead or consult your dealer.

BE SURE to replace the fuse only with an identical approved type, as originally fitted, and to replace the fuse cover.

If nonetheless the mains plug is cut off be sure to remove the fuse and dispose of the plug immediately, to avoid possible shock hazard by inadvertent connection to the mains supply.

If this product is not supplied fitted with a mains plug then follow the instructions given below:

DO NOT make any connection to the Larger Terminal coded E or Green.

The wires in the mains lead are coloured in accordance with the following code:



If these colours do not correspond with the terminal identifications of your plug, connect as follows:

Blue wire to terminal coded N (Neutral) or coloured black.

Brown wire to terminal coded L (Live) or coloured Red.

If in doubt — consult a competent electrician.

WARNING: TO PREVENT FIRE OR SHOCK HAZARD, DO NOT EXPOSE THIS UNIT TO RAIN OR MOISTURE.**CAUTIONS:**

- To prevent shock, do not open the cabinet. No user serviceable parts inside. Refer servicing to qualified personnel.
- When you are not using the AC adapter for a long period of time, it is recommended that you disconnect the power cord from AC outlet.

CAUTION:

To avoid electric shock or damage to the unit, first firmly insert the small end of the power cord into the AC Adapter until it is no longer wobbly, and then plug the larger end of the power cord into an AC outlet.

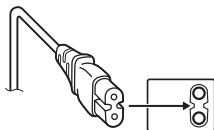
**CAUTIONS:**

- This camera is designed to be used with PAL-type colour television signals. It cannot be used for playback with a television of a different standard. However, live recording and LCD monitor playback are possible anywhere.
- Use the JVC BN-VF707U battery pack and, to recharge it or to supply power to the camera from an AC outlet, use the provided multi-voltage AC adapter. (An appropriate conversion adapter may be necessary to accommodate different designs of AC outlets in different countries.)

NOTES:

- The rating plate and safety caution are on the bottom and/or the back of the main unit.
- The serial number plate is on the battery pack mount.
- The rating information and safety caution of the AC adapter are on its upper and lower sides.

Do not point the lens directly into the sun. This can cause eye injuries, as well as lead to the malfunctioning of internal circuitry. There is also a risk of fire or electric shock.

CAUTION!

The following notes concern possible physical damage to the camera and to the user.

Carrying or holding the camera by the LCD monitor can result in dropping the unit, or in a malfunction.

Do not use a tripod on unsteady or unlevel surfaces. It could tip over, causing serious damage to the camera.

CAUTION!

Connecting cables (Audio/Video, S-Video, etc.) to the camera and leaving it on top of the TV is not recommended, as tripping on the cables will cause the camera to fall, resulting in damage.

Information for Users on Disposal of Old Equipment

[European Union]

This symbol indicates that the electrical and electronic equipment should not be disposed as general household waste at its end-of-life. Instead, the product should be handed over to the applicable collection point for the recycling of electrical and electronic equipment for proper treatment, recovery and recycling in accordance with your national legislation.



Attention:

This symbol is only valid in the European Union.

By disposing of this product correctly, you will help to conserve natural resources and will help prevent potential negative effects on the environment and human health which could otherwise be caused by inappropriate waste handling of this product. For more information about collection point and recycling of this product, please contact your local municipal office, your household waste disposal service or the shop where you purchased the product.

Penalties may be applicable for incorrect disposal of this waste, in accordance with national legislation.

[Business users]

If you wish to dispose of this product, please visit our web page www.jvc-europe.com to obtain information about the take-back of the product.

[Other Countries outside the European Union]

If you wish to dispose of this product, please do so in accordance with applicable national legislation or other rules in your country for the treatment of old electrical and electronic equipment.

When the equipment is installed in a cabinet or on a shelf, make sure that it has sufficient space on all sides to allow for ventilation (10 cm or more on both sides, on top and at the rear).

Do not block the ventilation holes. (If the ventilation holes are blocked by a newspaper, or cloth etc. the heat may not be able to get out.)

No naked flame sources, such as lighted candles, should be placed on the apparatus.

When discarding batteries, environmental problems must be considered and the local rules or laws governing the disposal of these batteries must be followed strictly.

The apparatus shall not be exposed to dripping or splashing.

Do not use this equipment in a bathroom or places with water.

Also do not place any containers filled with water or liquids (such as cosmetics or medicines, flower vases, potted plants, cups etc.) on top of this unit. (If water or liquid is allowed to enter this equipment, fire or electric shock may be caused.)

SOME DO'S AND DON'TS ON THE SAFE USE OF EQUIPMENT

This equipment has been designed and manufactured to meet international safety standards but, like any electrical equipment, care must be taken if you are to obtain the best results and safety is to be assured.

DO read the operating instructions before you attempt to use the equipment.

DO ensure that all electrical connections (including the mains plug, extension leads and interconnections between pieces of equipment) are properly made and in accordance with the manufacturer's instructions. Switch off and withdraw the mains plug when making or changing connections.

DO consult your dealer if you are ever in doubt about the installation, operation or safety of your equipment.

DO be careful with glass panels or doors on equipment.

DON'T continue to operate the equipment if you are in any doubt about it working normally, or if it is damaged in any way — switch off, withdraw the mains plug and consult your dealer.

DON'T remove any fixed cover as this may expose dangerous voltages.

DON'T leave equipment switched on when it is unattended unless it is specifically stated that it is designed for unattended operation or has a standby mode. Switch off using the switch on the equipment and make sure that your family knows how to do this. Special arrangements may need to be made for infirm or handicapped people.

DON'T use equipment such as personal stereos or radios so that you are distracted from the requirements of road safety. It is illegal to watch television whilst driving.

DON'T listen to headphones at high volume, as such use can permanently damage your hearing.

DON'T obstruct the ventilation of the equipment, for example with curtains or soft furnishings. Overheating will cause damage and shorten the life of the equipment.

DON'T use makeshift stands and **NEVER** fix legs with wood screws — to ensure complete safety always fit the manufacturer's approved stand or legs with the fixings provided according to the instructions.

DON'T allow electrical equipment to be exposed to rain or moisture.

ABOVE ALL

- **NEVER** let anyone especially children push anything into holes, slots or any other opening in the case — this could result in a fatal electrical shock;
- **NEVER** guess or take chances with electrical equipment of any kind — it is better to be safe than sorry!

Before Using this Camera

This camera records video in MPEG2 format compliant with SD-VIDEO format.

Remember that this camera is not compatible with other digital video formats.

Remember that this camera is intended for private consumer use only.

Any commercial use without proper permission is prohibited. (Even if you record an event such as a show, performance or exhibition for personal enjoyment, it is strongly recommended that you obtain permission beforehand.)

Do not strike or shake the hard disk.

Before recording important video, be sure to make a trial recording.

Play back your trial recording to make sure the video and audio have been recorded properly.

Make a backup of important recorded data

Protect your important recorded data by copying the files to PC. It is recommended to copy it from your PC to a DVD or other recording media for storage. Refer to the software installation and USB connection guide.

Important notes when requesting repair or inspection

When the camera is repaired or inspected, data may be erased, and the hard disk may be formatted. Back up all data before requesting repair or inspection.

If a problem occurs with the SD Memory Card, bring the card together with the camera.

When requesting repairs for breakdowns by your dealer or JVC service centre, be sure to bring your camera together with the SD Memory Card. If one of them is not included, the cause cannot be diagnosed, and the repair cannot be made properly.

Important notes for destroying and disposing of camera

When formatting or erasing data using the camera or PC functions, only the file administration information is changed. The data is not completely erased from the hard disk. If you want to completely erase all of the data, we recommend either using commercially available software that is specially designed for that purpose, or by physically destroying the camera with a hammer etc.

Also read "Cautions" on pages 57 to 59.

- Manufactured under license from Dolby Laboratories. "Dolby" and double-D symbol are trademarks of Dolby Laboratories.
-  MascotCapsule is registered trademark of HI CORPORATION in Japan.
Copyright © 2001 HI CORPORATION. All rights reserved.
- Other product and company names included in this instruction manual are trademarks and/or registered trademarks of their respective holders.

Provided Accessories

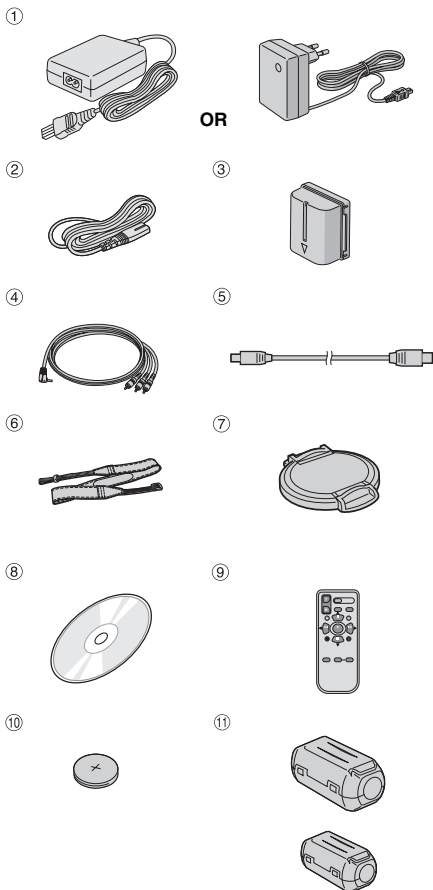

- ① AC Adapter AP-V14E or AP-V17E
 - ② Power Cord (for AP-V14E only)
 - ③ Battery Pack BN-VF707U
 - ④ Audio/Video Cable
 - ⑤ USB Cable (Refer to the software installation and USB connection guide.)
 - ⑥ Shoulder Strap (See page 8 for attachment)
 - ⑦ Lens Cap (See page 8 for attachment)
 - ⑧ CD-ROM
 - ⑨ Remote Control Unit RM-V730UE
 - ⑩ Lithium Battery CR2025* (for remote control unit)
 - ⑪ Core Filter for Cables (See page 9 for attachment)
 - Large (x 1): USB Cable
 - Small (x 1): DC Cord
- * A lithium battery is pre-installed in the remote control unit at time of shipment (with insulation sheet). To use the remote control unit, remove the insulation sheet.

NOTES:

- In order to maintain optimum performance of the camera, provided cables may be equipped with one or more core filter. If a cable has only one core filter, the end that is closest to the filter should be connected to the camera.
- Make sure to use the provided cables for connections. Do not use any other cables.

Attaching the Shoulder Strap

Follow the illustration.

- 1 Open the velcro strip.
- 2 Thread the strap through the eyelet.
- 3 Fold it back and thread it through the strap guide and the buckle.
 - To adjust the length of the strap, loosen and then tighten the strap in the buckle.
- 4 Slide the strap guide fully towards the eyelet.
- 5 Close the velcro strip.

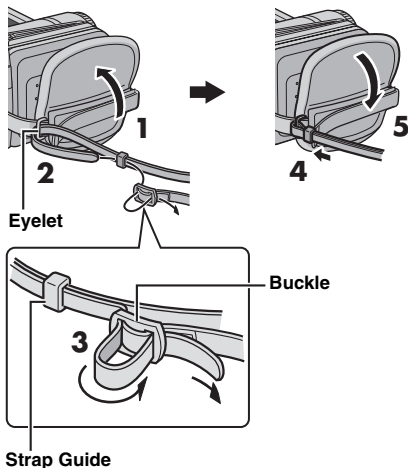

Attaching the Lens Cap

To protect the lens, attach the provided lens cap to the camera as shown in the illustration.

NOTE:

To confirm the lens cap is on correctly, make sure the cap is flush to the camera.

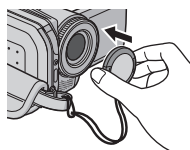
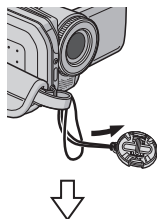
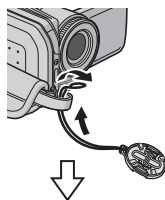
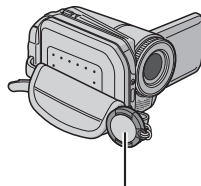

Attaching the Core Filter

Attach the core filters to the cables. The core filter reduces interference.

1 Release the stoppers on both ends of the core filter.



2 Run the cable through the core filter, leaving approx. 3 cm of cable between the cable plug and the core filter.

S-Video/Audio/Video/USB cable

Wind the cable once around the outside of the core filter as shown in the illustration.

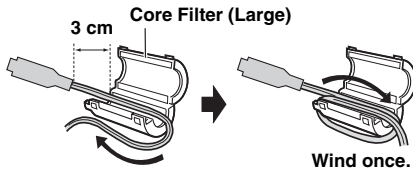

DC cord

Wind the cord twice around the outside of the core filter as shown in the illustration.

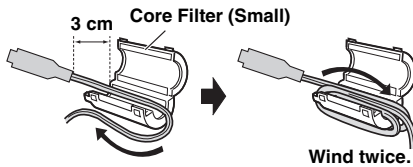

- Wind the cable so that it is not slack.

3 Close the core filter until it clicks shut.

S-Video/Audio/Video/ USB Cable

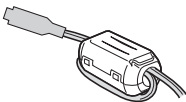

DC Cord

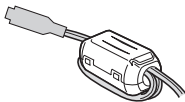

NOTES:

- Take care not to damage the cable.
- When connecting a cable, attach the end with the core filter to the camera.

LCD Monitor

Push the release button (A) and open the LCD monitor fully. It can rotate 270°.

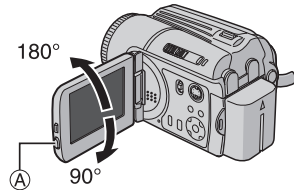

Index

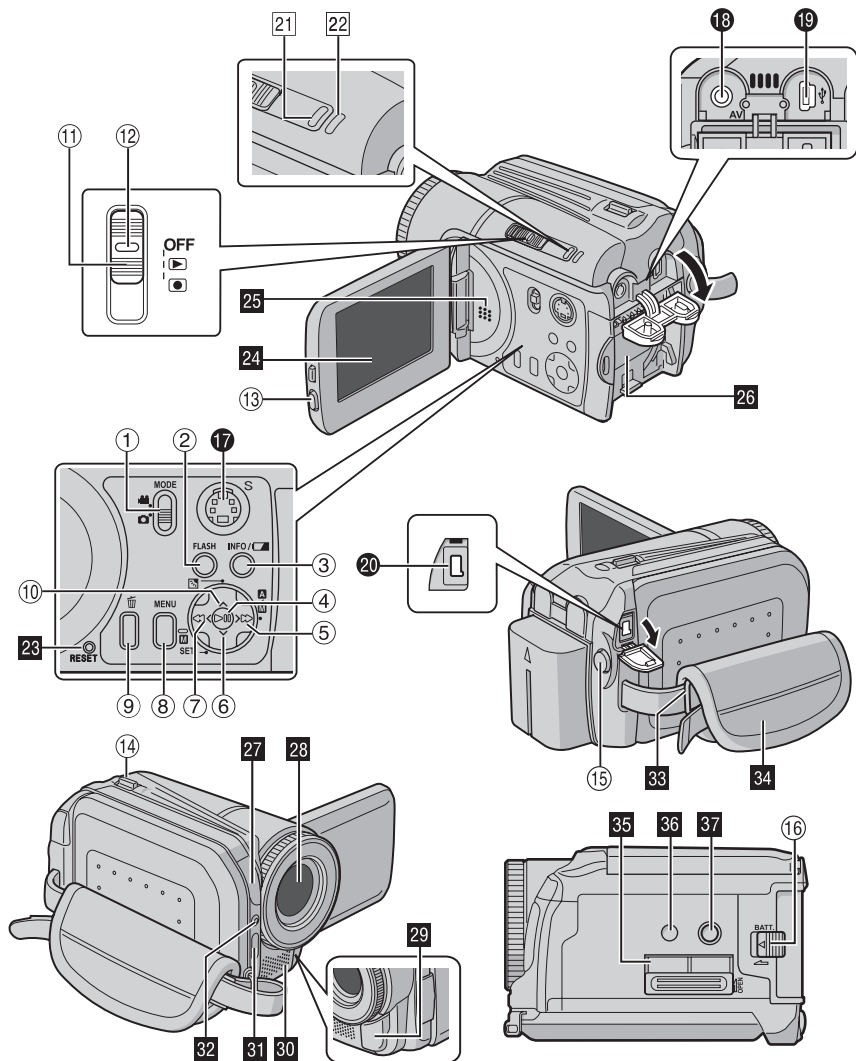
**ATTENTION:**

- Be careful not to cover **27**, **28**, **29**, **30**, **31** and **32** during shooting.
- Be careful not to cover **25** during playback.

Controls

- ① Mode Switch [MODE] (☞ pg. 16 – 17)
- ② Flash Button [FLASH] (☞ pg. 31)
- ③ Information Button [INFO/⏏] (☞ pg. 38)
- ④ Play/Pause Button [▶||] (☞ pg. 24, 29)
- ⑤ Forward Search Button [> (▶▶)] (☞ pg. 25)/
Right Button [>]/Auto/Manual Mode Switch
[⏏/⏏] (☞ pg. 16 – 17)
- ⑥ Forward Skip Button [>] (☞ pg. 25)/Down
Button [<]/Manual Set Button [⏏ SET]
(☞ pg. 32)
- ⑦ Reverse Search Button [< (◀◀)] (☞ pg. 25)/
Left Button [<]
- ⑧ Menu Button [MENU] (☞ pg. 48)
- ⑨ Delete Button [⏏] (☞ pg. 39)
- ⑩ Reverse Skip Button [^] (☞ pg. 25)/Up
Button [^]/Backlight Compensation Button
[⏏] (☞ pg. 31)/Spot Exposure Control
Button (☞ pg. 31)
- ⑪ Power Switch [OFF, ▶, ●] (☞ pg. 16)
- ⑫ Lock Button (☞ pg. 16)
- ⑬ LCD Release Button
- ⑭ Zoom Lever [T Q/W ⏏] (☞ pg. 23)
Speaker Volume Control (☞ pg. 24)
- ⑮ Recording Start/Stop Button (☞ pg. 22, 28)
- ⑯ Battery Release Button [BATT.] (☞ pg. 14)

Connectors

The connectors are located beneath the covers.

- ⑰ S-Video Output Connector [S] (☞ pg. 26)
- ⑱ Audio/Video Output Connector [AV]
- ⑲ USB (Universal Serial Bus) Connector (Refer
to the software installation and USB
connection guide.)
- ⑳ DC Input Connector [DC] (☞ pg. 14)

Indicators

- ㉑ Power/Charge Lamp [POWER/CHARGE]
(☞ pg. 14, 16)
- ㉒ Access Lamp [ACCESS] (Lights up or blinks
when you access to any files. Do not turn off
the power or remove the battery pack/AC
adapter while accessing to files.)

Other Parts

- ㉓ Reset Hole [RESET] (☞ pg. 52)
- ㉔ LCD Monitor
- ㉕ Speaker (☞ pg. 24)
- ㉖ Battery Pack Mount (☞ pg. 14)
- ㉗ Camera Sensor
- ㉘ Lens
- ㉙ Remote Sensor (☞ pg. 27)
- ㉚ Stereo Microphone
- ㉛ Flash (☞ pg. 31)
- ㉜ Flash Sensor
- ㉝ Shoulder Strap Eyelet (☞ pg. 8)
- ㉞ Grip Strap (☞ pg. 19)
- ㉟ SD Card Cover [OPEN] (☞ pg. 19)
- ㊱ Stud Hole (☞ pg. 19)
- ㊲ Tripod Mounting Socket (☞ pg. 19)

Indications on LCD Monitor

During both Video and Still Image Recording

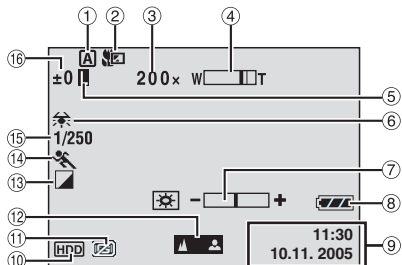

- ① Selected Operation Mode Indicator (⇨ pg. 17)
A: Auto Mode
M: Manual Mode
- ② Tele Macro Mode Indicator (⇨ pg. 50)
- ③ Approximate Zoom Ratio (⇨ pg. 23, 50)
- ④ Zoom Indicator (⇨ pg. 23, 50)
- ⑤ Iris Lock Indicator (⇨ pg. 31, 32)
- ⑥ White Balance Indicator (⇨ pg. 34)
- ⑦ Brightness Control Indicator (⇨ pg. 18, 49)
- ⑧ Battery Indicator (⇨ pg. 55)
- ⑨ Date/Time (⇨ pg. 49)
- ⑩ Selected Medium Indicator (⇨ pg. 21, 49)
- ⑪ Drop Detection Indicator (⇨ pg. 21)
- ⑫ Manual Focus Adjustment Indicator (⇨ pg. 33)
- ⑬ Effect Mode Indicator (⇨ pg. 36)
- ⑭ Program AE Mode Indicator (⇨ pg. 36)
- ⑮ Shutter Speed (⇨ pg. 35)
☀: Nightscope Indicator
- ⑯ ±: Exposure Adjustment Indicator (⇨ pg. 32)
☀: Backlight Compensation Indicator (⇨ pg. 31)
●: Spot Exposure Control Indicator (⇨ pg. 31)

During Video Recording only

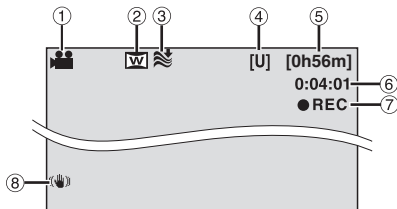

- ① Mode Indicator (⇨ pg. 17)
- ② Wide Mode Indicator (⇨ pg. 50)
- ③ Wind Cut Indicator (⇨ pg. 50)
- ④ Picture Quality: [U] (ultra fine), [F] (fine), [N] (normal), [E] (economy) (⇨ pg. 50)
- ⑤ Remaining Time (⇨ pg. 22, 62)
- ⑥ Counter (⇨ pg. 49)
- ⑦ ● REC: (Appears during recording.) (⇨ pg. 22)
■: (Appears during record-standby mode.) (⇨ pg. 22)
- ⑧ Digital Image Stabiliser (DIS) Indicator (⇨ pg. 50)

During Still Image Recording only

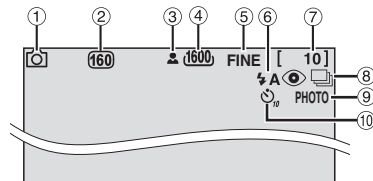

- ① Mode Indicator (⇨ pg. 17)
- ② ISO sensitivity (GAIN) (⇨ pg. 51)
 (When set to [AUTO], there is no indication.)
- ③ Focus Icon (⇨ pg. 28)
- ④ Image Size: 1600 (1600 x 1200), 1280 (1280 x 960), 1024 (1024 x 768), 640 (640 x 480) (⇨ pg. 51)
- ⑤ Picture Quality: FINE (fine) or STD (standard) (⇨ pg. 51)
- ⑥ Flash Mode Indicator (⇨ pg. 31)
- ⑦ Remaining Number of Shots (⇨ pg. 63)
- ⑧ 📷: Continuous Shooting Mode Indicator (⇨ pg. 28)
- ⑨ Shooting Icon (⇨ pg. 28)
- ⑩ Self-Timer Recording Indicator (⇨ pg. 51)

During Video Playback

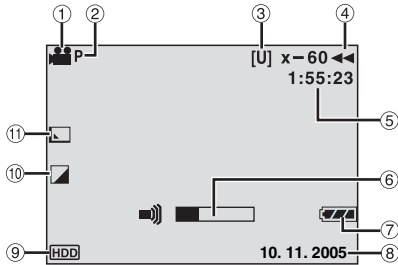

- ① Mode Indicator (☞ pg. 17)
- ② Play List Playback Indicator (Appears when play list is played back. ☞ pg. 43)
- ③ Picture Quality: [U] (ultra fine), [F] (fine), [N] (normal), [E] (economy) (☞ pg. 50)
- ④ Playback Mode (☞ pg. 24)
 - ▶ : Playback
 - ⏸ : Pause
 - ▶▶ : Forward High-Speed Search
 - ◀◀ : Reverse High-Speed Search
 - ▶▶▶ : Forward Slow-Motion
 - ◀◀◀ : Reverse Slow-Motion
 (The number on the left shows speed.)
- ⑤ Counter (☞ pg. 49)
- ⑥ Volume Level Indicator
- ⑦ Battery Indicator (☞ pg. 55)
- ⑧ Date (☞ pg. 49)
- ⑨ Selected Medium Indicator (☞ pg. 21, 49)
- ⑩ Effect Mode Indicator (☞ pg. 37)
- ⑪ Wipe/Fader Effect Indicator (☞ pg. 37, 50)

During Still Image Playback

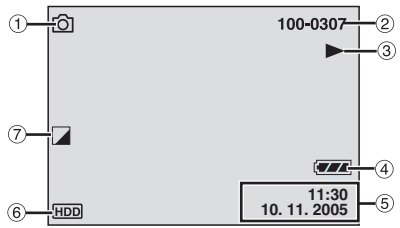

- ① Mode Indicator (☞ pg. 17)
- ② Folder/File Number
- ③ Slide Show Playback Indicator (☞ pg. 29)
- ④ Battery Indicator (☞ pg. 55)
- ⑤ Date/Time (☞ pg. 49)
- ⑥ Selected Medium Indicator (☞ pg. 21, 49)
- ⑦ Effect Mode Indicator (☞ pg. 37)

Power

This camera's 2-way power supply system lets you choose the most appropriate source of power. Do not use provided power supply units with other equipment.

Charging the Battery Pack

Power/Charge Lamp

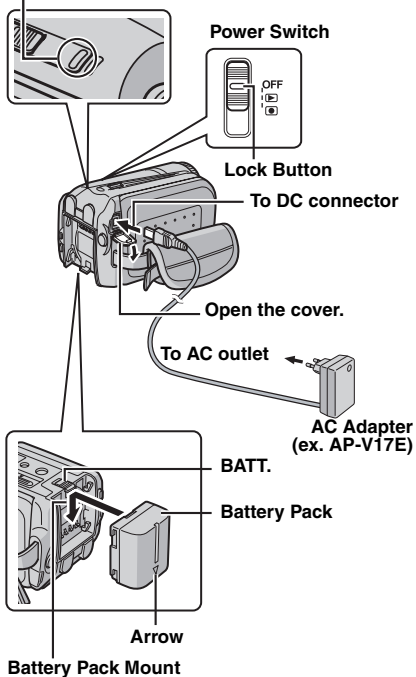

- 1** Set the power switch to **OFF**.
- 2** With the arrow on the battery pack pointing downward, push the battery pack slightly against the battery pack mount.
 - If the battery mount cover is attached, remove it by sliding **BATT.**
- 3** Slide down the battery pack until it locks in place.
- 4** Connect the AC adapter to the camera.
- 5** Connect the power cord to the AC adapter. (for AP-V14E only)
- 6** Plug the power cord into an AC outlet. The power/charge lamp on the camera blinks to indicate charging has started.
- 7** When the power/charge lamp goes out, charging is finished. Unplug the power cord from the AC outlet. Disconnect the AC adapter from the camera.

To detach the battery pack

While sliding **BATT.**, remove the battery pack.

Required charging time

Battery pack	Charging time
BN-VF707U*	Approx. 1 hr. 30 min.
BN-VF714U	Approx. 2 hr. 40 min.
BN-VF733U	Approx. 5 hr. 40 min.

* Provided

NOTES:

- This product includes patented and other proprietary technology and will operate only with JVC Data Battery. Use the JVC BN-VF707U/VF714U/VF733U battery packs. Using generic non-JVC batteries can cause damage to the internal charging circuitry.
- If the protective cap is attached to the battery pack, remove it first.
- During charging, the camera cannot be operated.
- Charging is not possible if the wrong type of battery is used.
- Make sure to use the battery pack with the arrow (Δ) mark. The camera does not turn on with the battery pack without the arrow (Δ) mark.
- When charging the battery pack for the first time or after a long storage period, the power/charge lamp may not light. In this case, remove the battery pack from the camera, then try charging again.
- If the battery operation time remains extremely short even after having been fully charged, the battery is worn out and needs to be replaced. Please purchase a new one.
- Since the AC adapter processes electricity internally, it becomes warm during use. Be sure to use it only in well-ventilated areas.
- Using the optional AA-VF7 battery charger, you can charge the BN-VF707U/VF714U/VF733U battery pack without the camera.
- After 5 minutes has elapsed in record-standby mode, the camera will automatically turn off its power supplied from the AC adapter. In this case, the battery charge starts if the battery is attached to the camera.

Using the Battery Pack

Perform steps **2 – 3** in “Charging the Battery Pack” (☞ pg. 14).

Maximum continuous recording time

Battery pack	Recording time
BN-VF707U*	Approx. 50 min.
BN-VF714U	Approx. 1 hr. 50 min.
BN-VF733U	Approx. 4 hr. 20 min.

* Provided

NOTES:



- Recording time is reduced significantly under the following conditions:
 - Zoom or record-standby mode is engaged repeatedly.
 - Playback mode is engaged repeatedly.
- Before extended use, it is recommended that you prepare enough battery packs to cover 3 times the planned recording time.

ATTENTION:

- Before detaching the power source, make sure that the camera's power is turned off. Failure to do so can result in a camera malfunction.
- If the camera is subjected to electrostatic discharge, turn the power off before using it again.

Data Battery System

You can check the remaining battery power and the recordable time.

- 1 Make sure the battery is attached.
- 2 Open the LCD monitor fully.
- 3 Press **INFO**/ repeatedly, and the battery status screen appears.
 - It is displayed for approx. 3 seconds if the button is pressed and released quickly, and for approx. 15 seconds if the button is pressed and held for several seconds.
 - If “COMMUNICATING ERROR” appears instead of the battery status even though you tried to press **INFO**/ several times, there may be a problem with your battery. In such a case, consult your nearest JVC dealer.
 - The recordable time display should only be used as a guide. It is displayed in 10 minute units.

Using AC Power

Perform step 4 in “Charging the Battery Pack” ( pg. 14).

NOTE:

The provided AC adapter features automatic voltage selection in the AC range from 110 V to 240 V.

About Batteries



DANGER! Do not attempt to take the batteries apart, or expose them to flame or excessive heat, as it may cause a fire or explosion.

WARNING! Do not allow the battery or its terminals to come in contact with metals, as this can result in a short circuit and possibly start a fire.

To resume the original function of the accurate battery power indication

If the battery power indication differs from the actual operating time, fully charge the battery, and then run it down. However this function may not work properly if the battery was used for a long period of time under extremely high/low temperature condition or charged too many times.

Operation Mode

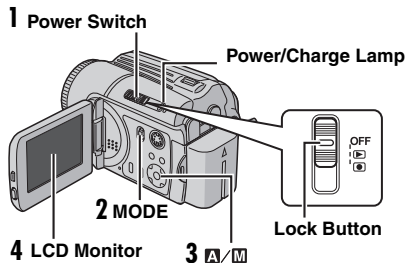

To turn on the camera, set the power switch to  or  while pressing down the lock button located on the switch.

- The power/charge lamp turns on.
- To turn off the camera, set the power switch to **OFF**.



Set the appropriate operation mode according to your preference using the power and **MODE** switches and  (**A/M**) button.

1 Power Switch Position

Set the power switch for recording () or playback () while pressing down the lock button.

Power Switch

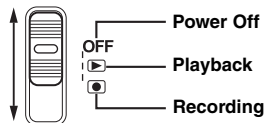

2 Recording/Playback Mode

Select the recording/playback mode using the **MODE** switch.

 : Video mode (☞ pg. 22, 24)

 : Still image mode (☞ pg. 28, 29)

3 Auto/Manual Mode

Press and hold \triangleright (**A/M**) to switch the auto/manual recording mode. When manual mode is selected, the indicator **M** appears on the LCD monitor.



Auto mode:

You can record without using special effects or manual adjustments.

Manual mode:

Manual recording is possible by setting various functions.
(☞ pg. 31 – 37)

To return to the auto recording mode



Press and hold \triangleright (**A/M**) again so that the **A** indicator appears.

4 Power-Linked Operation

When the power switch is set to , you can also turn on/off the camera by opening/closing the LCD monitor.

Language Setting

The language on the display can be changed.
(☞ pg. 48, 49)

1 Set the power switch to  or .

2 Press **MENU**. The menu screen appears.

3 Press \wedge / \vee to select [DISPLAY], then press \blacktriangleright .



4 Press \wedge / \vee to select [LANGUAGE], then press \blacktriangleright .

5 Press \wedge / \vee to select the desired language, then press \blacktriangleright .





6 Press **MENU** to return to the normal screen.

Date/Time Settings

The recording start date/time is recorded on the video/still image file and it can be checked by pressing **INFO**/ during playback.

( pg. 24, 29)



In addition, you can find the desired file by the date index screen. ( pg. 30)

1 Set the power switch to  or .



2 Press **MENU**. The menu screen appears.

3 Press / to select [DISPLAY], then press .



4 Press / to select [CLOCK ADJUST], then press . The day is highlighted.



5 Press / to input the day, then press . Repeat to input the month, year, hour and minute.

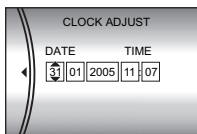

6 Press **MENU** to return to the normal screen.



Built-in Clock's Rechargeable Lithium Battery

If the camera is not used for approx. 3 months, the clock's lithium battery will become discharged and the date/time stored in memory will be lost. When this occurs, first connect the camera to an AC outlet using the AC adapter for over 24 hours to charge the clock's rechargeable lithium battery. Then perform the date/time setting before using the camera.

Note that the camera can be used without setting the date/time.



Brightness Adjustment of the Display



The brightness of the display can be adjusted.

1 Set the power switch to  or  while pressing down the lock button located on the switch.



2 Open the LCD monitor fully. ( pg. 9)

3 Press **MENU**. The menu screen appears.

4 Press / to select [DISPLAY], then press .

5 Press / to select [BRIGHT], and press . The brightness control indicator appears.



6 Press / until the appropriate brightness is reached.

7 Press  to clear the brightness control indicator from the display.

Grip Adjustment

- 1 Adjust the velcro strip.
- 2 Pass your right hand through the loop and grasp the grip.
- 3 Adjust your thumb and fingers to easily operate the recording start/stop button, power switch and zoom lever. Be sure to fasten the velcro strip to your preference.

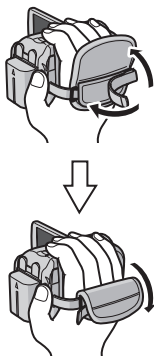

Tripod Mounting

To attach the camera to a tripod, align the direction stud and screw to the mounting socket and stud hole on the camera. Then tighten the screw clockwise.

- Some tripods are not equipped with studs.

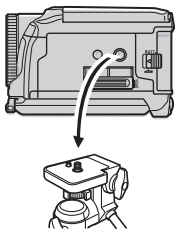

Inserting/Removing an SD Card

You can use an SD card as a recording medium in the SD slot. See page 62 for the guaranteed media to work with this camera.

Clipped Edge

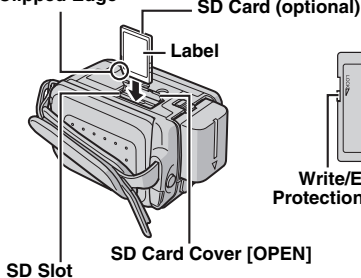

GETTING STARTED

- 1 Make sure the camera's power is off.
- 2 Open the SD card cover.

3 To insert an SD card, firmly insert it with its clipped edge first.

To remove an SD card, push it once. After the SD card comes out of the camera, pull it out.

- Do not touch the terminal on the reverse side of the label.

- 4 Close the SD card cover.

To protect valuable files

Slide the write/erase protection tab on the side of the SD card in the direction of "LOCK". This prevents the SD card from being recorded over. To record on this SD card, slide the tab back to the position opposite to "LOCK" before inserting it.

NOTE:

Before using a new SD card, it is necessary to format the card. (▶ pg. 20)



ATTENTION:

Do not insert or remove the SD card while the camera is turned on, as this may cause the data on the SD card to be corrupted or cause the camera to become unable to recognise whether or not the SD card is installed.

Formatting a Recording Medium

You can format (initialise) the built-in hard disk (HDD) or SD cards. You have to format the newly-purchased SD cards with this camera before using them. This enables stable speeds and operation when accessing the recording medium. Be aware that all files and data including protected files will be erased.

(▶ pg. 38)

1 Set the power switch to  or .

2 Press **MENU**. The menu screen appears.

3 Press \wedge / \vee to select [REC MEDIA SETTING], then press \blacktriangleright .



4 Press \wedge / \vee to select [FORMAT], then press \blacktriangleright .



5 Press \wedge / \vee to select [HDD] or [SD], then press \blacktriangleright .

6 Press \wedge / \vee to select [EXECUTE], then press \blacktriangleright .

• To cancel the formatting, select [CANCEL], then press \blacktriangleright .

To make it more difficult to recover the data on the hard disk

Even if you format the hard disk or erase the data on the hard disk, sometimes the erased data can be recovered by using data recovery software etc. that are commercially available. By pressing the \blacktriangleright button while selecting [HDD] and holding down the  button in step **5**, you can erase the data on the hard disk in a format that is difficult to recover. Moreover, by repeating this procedure, you can make the data even more difficult to recover.

- When formatting in this way, a formatting progress bar is displayed.
- If the formatting progress bar does not appear, select [CANCEL] and try again from step **4**.

CAUTION:

Do not remove the SD card or perform any other operation (such as turning off the power) during format. Also, be sure to use the provided AC adapter, as the data on the recording medium may be corrupted if the battery becomes exhausted during format. If the data on the recording medium becomes corrupted, format it again.

NOTE:

Do not format the recording medium on the PC. Make sure to format the recording medium on the camera.

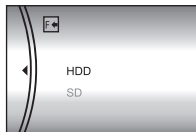

Selecting a Recording Medium

Select the recording medium before starting recording or playback. (☞ pg. 48, 49)

Example: When recording still images to an SD card

- 1 Set the power switch to or .
- 2 Press **MENU**. The menu screen appears.
- 3 Press \wedge / \vee to select [REC MEDIA SETTING], then press \blacktriangleright .
- 4 Press \wedge / \vee to select [IMAGE MODE], then press \blacktriangleright .
- 5 Press \wedge / \vee to select [SD], then press \blacktriangleright .
- 6 Press **MENU** to return to the normal screen.



Drop Detection

This function turns off the power automatically to prevent HDD damage when the camera is accidentally dropped. This function is set to on at time of shipment.

If the power is turned off due to the drop detection function, set the power switch to **OFF**, and turn the power on again.

To turn off this function

Set [DROP DETECTION] to [OFF]. The indicator appears. (☞ pg. 49)

CAUTION:

Setting this function to off increases the chances of damaging the internal hard disk if the camera is accidentally dropped.

NOTES:

- This function cannot protect the hard disk every single time it is dropped.
- The indicator is only displayed when this function is set to [OFF]. For normal use, set this function to [ON].
- If the drop detection function operates when the camera has not been dropped, set the function to [OFF] to continue use.
- If a drop is detected during shooting, the file being shot when the camera was dropped may be saved in the [EXTMOV] folder. (☞ pg. 22)

Remaining Space on the Recording Media

This enables you to check the remaining space on the recording media and the available recording time for each picture quality mode. Before checking, set the recording media that you want to check in [REC MEDIA SETTING]. (☞ pg. 48, 49)

Example: When checking the HDD space

- 1 Set the power switch to .
- 2 Press **INFO**/. The MAX RECORDING TIME screen appears.

Displayed picture quality mode

- U**: ULTRA FINE
- F**: FINE
- N**: NORMAL
- E**: ECONOMY

For details on the picture quality, see page 50.

To return to the normal screen

Press **INFO**/ repeatedly.

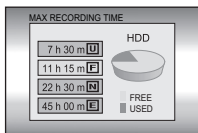

Video Recording

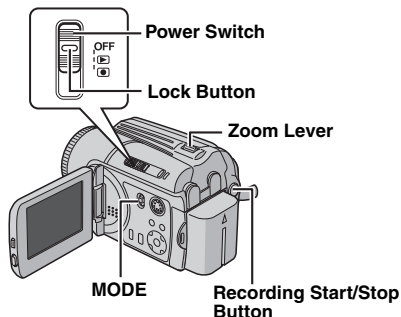

1 Set the power switch to .

2 Set the **MODE** switch to .

- The camera is programmed to record videos on the built-in hard disk by the factory-preset. To switch the recording medium, see pages 21, 48 and 49.
- To change the picture quality, see pages 48 and 50.

3 Press the recording start/stop button to start recording.



- Approximate remaining time for recording appears on the display.

[U] [0h56m]

●REC

4 To stop recording, press the recording start/stop button again.

NOTES:

- If the camera is left without any operation during recording or playback (video or still image) for 5 minutes when using the battery pack, the camera is turned off automatically to conserve power. To turn the camera on again, set the power switch to **OFF**, then to  or . When using the AC adapter, the camera enters the sleep mode (the access lamp lights and the LCD monitor turns off). To cancel the sleep mode, perform any operation such as zooming.
- When the camera heats up, the ●REC indicator flashes. If the camera continues to heat up, shooting may be stopped to protect the recording medium. In this case, turn off the power, and then wait until the camera cools down. (⇨ pg. 56)
- If data cannot be recorded or saved properly, the video files are not saved to the [SD_VIDEO] folder, which is for regular videos. Instead, the files are saved to the [EXTMOV] folder. To play back these files, see "To play back files in the [EXTMOV] folder" (⇨ pg. 24).
- There may be differences in the brightness between the recorded video and still image, even if the same subject is shot.
- Video file names are assigned as sequential hexadecimal numbers. For example, starts from 1 to 9 followed by A to F.
- To turn the operation sounds off, see page 48.
- For approximate recording time, see page 62.
- After recording video for 12 consecutive hours, the recording will be stopped automatically.
- When recording video, a new file will be created for every 4 GB of continuous shooting.

Zooming

Use the zoom function for close-up or wide-angle shooting. You can zoom in up to 10x by using the optical zoom.

To zoom in

Slide the zoom lever towards **T** (telephoto) (🔍).

To zoom out

Slide the zoom lever towards **W** (wide-angle) (📷).

W: Wide angle

T: Telephoto

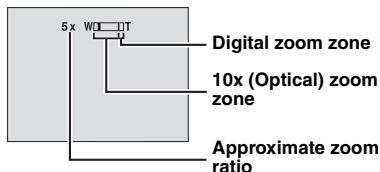
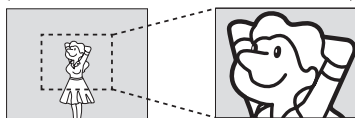

- The further you slide the zoom lever, the quicker the zoom action.
- Zoom magnification over 10x is done through digital image processing, and is therefore called digital zoom. Digital zooming is possible up to 200x. Set [ZOOM] to [40X] or [200X]. (☞ pg. 50)

NOTES:

- The S-Video cable is optional. Be sure to use the YTU94146A S-Video cable. Consult the JVC Service Centre described on the sheet included in the package for details on its availability. Make sure to connect the end with a core filter to the camera. The core filter reduces interference.
- Focusing may become unstable during zooming. In this case, set the zoom before recording and lock the focus by using the manual focus (☞ pg. 33), then zoom in or out during recording.
- During digital zoom, the quality of image may suffer.
- Macro shooting is possible as close as approx. 5 cm to the subject when the zoom lever is set all the way to **W**.
- When you zoom into a subject close to the lens, the camera may automatically zoom out depending on the distance to the subject. In this case, set [TELE MACRO] to [ON]. (☞ pg. 50)

Deleting Files

If you press  during recording mode, the file recorded most recently will be deleted.

- (☞ pg. 39)
- However, if the recording mode (video or still image) is switched or the power is turned off and on again after recording, you cannot delete the file.

Video Playback

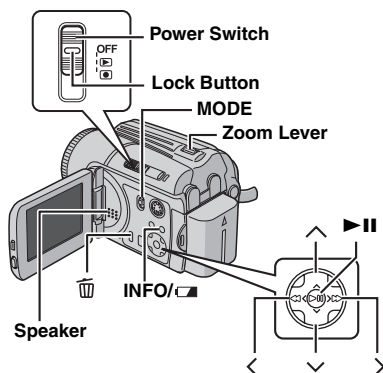

1 Set the power switch to .

2 Set the **MODE** switch to .

- The index screen for videos appears. The image on the index screen shows the first part of the shooting.
- If the power is turned off while video playback is paused, the camera memorizes the scene where the video was stopped. In this case, the stopped scene is displayed when the power is turned back on again.
- To switch the medium to be played back, see pages 21, 48 and 49.

3 Press /// to select the video file you want to play back.

4 Press to start playback.

5 To pause playback, press again.

To return to the index screen

Slide the zoom lever to **W** when playback is paused.

To adjust the speaker volume

During playback slide the zoom lever towards **T** to turn up the volume, or towards **W** to turn down the volume.

To turn on/off the date display

Set [DATE/TIME] to [ON], [AUTO] or [OFF].
(pg. 48, 49)

To turn on/off the on-screen display

Press **INFO**/ repeatedly.

To check the file information

Press **INFO**/ when playback is paused.
(pg. 38)

To play back files in the [EXTMOV] folder

If the data cannot be recorded properly, the video files are saved to the [EXTMOV] folder.
(pg. 22)

To play back the files in the [EXTMOV] folder, press the recording start/stop button or START/STOP button on the remote control while the index screen is displayed in step **2**, and then proceed to step **3** after [MPG] is displayed. To return to the index screen, press the recording start/stop button or START/STOP button on the remote control again.

- The file information and playlist creation functions are not available for files in the [EXTMOV] folder.

NOTES:

- The playback picture can be viewed in the LCD monitor or on a connected TV. (pg. 26)
- At the junctions between scenes, the image may stop momentarily or the sound may be interrupted. However, this is not a malfunction.
- The date and counter can be displayed during playback. (pg. 49)
- When the camera heats up, the indicator flashes. If the camera continues to heat up, playback may be stopped to protect the recording medium. In this case, turn off the camera power, and then wait until the camera cools down. (pg. 56)
- When a cable is connected to the AV connector, the sound is not heard from the speaker.

How to Use the Scroll Bar

You can use the vertical scroll bar on the index screen to find the desired files quickly. The scroll bar is useful when deleting files (☞ pg. 39), creating play list (☞ pg. 42), etc.

1 Slide the zoom lever towards **W** to select the scroll bar on the index screen.

2 Press \wedge/\vee to display the next or previous page.

- If you press and hold \wedge/\vee , the high speed search starts.
- If you find the desired file, slide the zoom lever towards **T**, then select the file.



Date Index Screen

You can also find the desired file by the date index screen. The files are sorted according to their recorded date.

1 Slide the zoom lever twice towards **W**. The date index screen appears.

2 Press \wedge/\vee to select the desired date. The files recorded on the selected date are displayed on the right side of the screen.

- Dates can also be selected by using the scroll bar on the right side of the screen. To select the scroll bar, slide the zoom lever towards **W** while on the date index screen, and press \wedge/\vee .

3 Press $\blacktriangleright\parallel$. The files recorded on the selected date are displayed in the index screen.

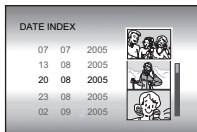

Various Playback Operations

Still playback (Pause)

Press $\blacktriangleright\parallel$ during normal playback.

- To resume normal playback, press $\blacktriangleright\parallel$ again.

Search playback

During normal playback, press \blacktriangleright for forward search, or \blacktriangleleft for reverse search.

- Pressing \blacktriangleleft or \blacktriangleright repeatedly increases the search speed for each direction. (-60x to +60x)
- To resume normal playback, press $\blacktriangleright\parallel$.

Locating the start point of the file or skipping the file

Press \vee to locate the start point of the next file. Pressing \vee repeatedly skips files in forward direction.

Press \wedge to locate the start point of the current file. Pressing \wedge repeatedly skips files in reverse direction.

- If you press \vee or \wedge during normal playback or search, playback resumes after locating the start point of a file.

Frame-by-frame playback

While playback is paused, press \blacktriangleleft or \blacktriangleright .

- Pressing \blacktriangleleft or \blacktriangleright repeatedly advances or reverses the still picture frame by frame.
- To resume normal playback, press $\blacktriangleright\parallel$.

Slow motion playback

While playback is paused, press and hold \blacktriangleleft or \blacktriangleright for over 2 seconds.

- To stop slow motion playback, press $\blacktriangleright\parallel$.

Playback Zoom

You can magnify the playback image up to 5x.

1 During normal playback, at the point you want to zoom in, press $\blacktriangleright\parallel$ to pause playback.

2 Slide the zoom lever towards **T** to zoom in.

- The full view of the image is displayed in the small screen on the lower right side. The \boxtimes mark indicates the centre point of the magnified area.

3 Press $\wedge/\vee/\blacktriangleleft/\blacktriangleright$ to move to the magnified area you want to view.

4 To zoom out, slide the zoom lever towards **W**.

- When the zoom is set all the way to **W** (wide-angle) side, sliding the zoom lever to **W** switches the display to the index screen. (☞ pg. 25)

Deleting Video Files

Press \boxtimes , then press \wedge/\vee to select [EXECUTE] and press $\blacktriangleright\parallel$.

- You can select the desired file to be deleted by pressing $\blacktriangleleft/\blacktriangleright$.
- To delete multiple files at once, see page 39.

Connecting to a TV, VCR or DVD Recorder

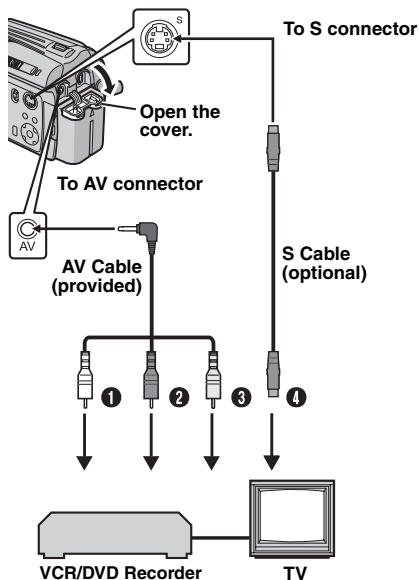

- ❶ White to AUDIO L IN*
- ❷ Red to AUDIO R IN*
- ❸ Yellow to VIDEO IN (Connect when your TV/VCR/DVD recorder has only A/V input connectors.)
- ❹ Black to S-VIDEO IN (Connect when your TV/VCR/DVD recorder has S-VIDEO IN and A/V input connectors. In this case, it is not necessary to connect the yellow video cable.)

* Not required for watching still images only.

NOTES:

- The S-Video cable is optional. Be sure to use the YU94146A S-Video cable. Consult the JVC Service Centre described on the sheet included in the package for details on its availability. Make sure to connect the end with a core filter to the camera. The core filter reduces interference.
- It is recommended to use the AC adapter as the power supply instead of the battery pack. (☞ pg. 16)
- Make sure you adjust the TV sound volume to its minimum level to avoid a sudden burst of sound when the camera is turned on.
- To connect the camera to a PC, refer to the software installation and USB connection guide.

Playback on a TV

- 1 Make sure all units are turned off.
 - 2 Connect the camera to a TV, VCR or DVD recorder as shown in the illustration.
- If using a VCR or DVD recorder, go to step 3. If not, go to step 4.**
- 3 Connect the VCR/DVD recorder output to the TV input, referring to your VCR/DVD recorder's instruction manual.
 - 4 Turn on the camera, the VCR/DVD recorder and the TV.
 - 5 Set the VCR/DVD recorder to its AUX input mode, and set the TV to its VIDEO mode.
 - 6 Start playback on the camera. (☞ pg. 24)

To choose whether or not the following displays appear on the connected TV

- Date/Time
Set [DATE/TIME] to [AUTO], [ON] or [OFF].
(☞ pg. 48, 49)
 - Counter
Set [SCENE COUNTER] to [ON] or [OFF].
(☞ pg. 48, 49)
- (Pressing **INFO**/ button also turns on/off the displays.)

Dubbing to a VCR (or DVD Recorder)

The following explains how to dub to a VCR. When dubbing to a DVD recorder, refer to its instruction manual.

- 1 Perform steps 1 to 6 above.
- 2 At the point you want to start dubbing, start recording on the VCR. (Refer to the VCR's instruction manual.)
- 3 To stop dubbing, stop recording on the VCR, then stop playback on the camera.

Playback Using the Remote Control

The full-function remote control unit can operate this camera from a distance as well as the basic operations (playback, stop, pause, fast-forward and rewind) of your VCR.

Installing the Battery

The remote control uses one lithium battery (CR2025).

1 Pull out the battery holder by pushing the lock tab.

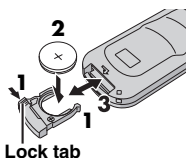

2 Insert the battery in the holder, and be sure to have the "+" mark visible.
3 Slide the holder back in until you hear a click.

Beam Effective Area

When using the remote control, be sure to point it at the remote sensor. The transmitted beam's approximate effective distance for indoor use is 5 m. Use the remote control in front of the camera facing toward the lens.

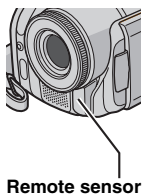

NOTE:

The transmitted beam may not be effective or may cause incorrect operation when the remote sensor is directly exposed to sunlight or powerful lighting.

Buttons and Functions

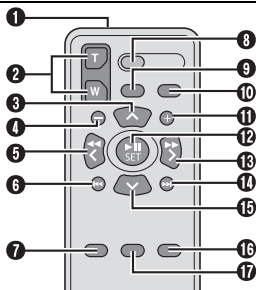

- 1** Infrared Beam Transmitting Window
 - Transmits the beam signal.
- 2** ZOOM (T/W) Buttons
Zoom In/Out (⇨ pg. 23)
- 3** Up Button
Rotate Button (clockwise) (⇨ pg. 30)
- 4** Skip Backward Button
- 5** Left Button
- 6** Back Button
- 7** PLAYLIST Button (⇨ pg. 42)
- 8** START/STOP Button
- 9** SNAPSHOT Button (⇨ pg. 28)
- 10** INFO Button (⇨ pg. 38)
- 11** Skip Forward Button
- 12** PLAY/PAUSE Button
- 13** Right Button
- 14** Next Button
- 15** Down Button
Rotate Button (counterclockwise) (⇨ pg. 30)
- 16** INDEX Button
- 17** DATE Button

Still Image Recording

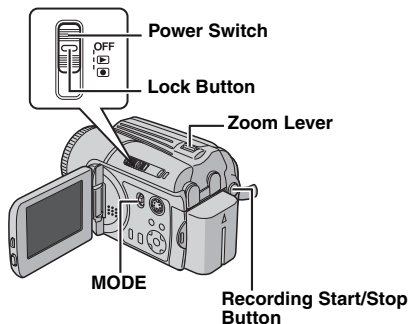

- 1 Set the power switch to .
- 2 Set the **MODE** switch to .
 - The camera is programmed to record still images on the built-in hard disk by the factory-preset. To switch the recording medium, see pages 21, 48 and 49.
 - To change the picture quality, see pages 48 and 51.
 - To use the flash, see page 31.
- 3 Press the recording start/stop button. **PHOTO** indicator appears during shooting. The still image is recorded.
 - To check how the image looks before recording, press the recording start/stop button halfway and hold. The  indicator appears and stops blinking when the captured image is focused. To cancel the recording, release the recording start/stop button. To record it on the recording medium, press the recording start/stop button fully.

NOTES:



- There may be differences in the brightness between the recorded video and still image, even if the same subject is shot.
- To turn the shutter sound off, see page 48.
- For approximate number of storable images, see page 63.

Zooming

Use the zoom function for close-up or wide-angle shooting. For details, see page 23.

Continuous Shooting

If the continuous shooting mode is set to on, keeping the recording start/stop button pressed in step 3 in “Still Image Recording” ( pg. 28) provides an effect similar to serial photography. (Interval between still images: approx. 0.5 seconds)

To use this function, set the [CONTINUOUS SHOOTING] to [ON]. ( pg. 51) The  indicator appears on the display.

- To turn off this function, set [CONTINUOUS SHOOTING] to [OFF].
- Continuous shooting may not work well depending on the recording medium.
- The continuous shooting speed will drop when repeatedly making continuous shots.

Deleting Files

If you press  during recording mode, the file recorded most recently will be deleted.

( pg. 39)

- However, if the recording mode (video or still image) is switched or the power is turned off and on again after recording, you cannot delete the file.

Still Image Playback

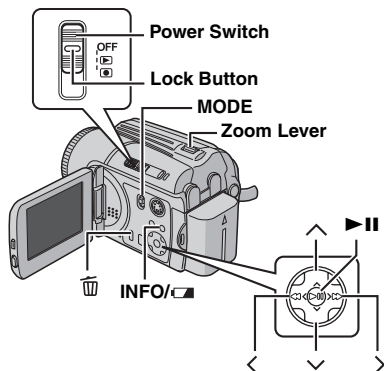

- 1 Set the power switch to .
- 2 Set the **MODE** switch to .
 - The most recently shot still image is displayed.
 - To switch the medium to be played back, see pages 21, 48 and 49.
- 3 Press to display the previous file. Press to display the next file.

To turn on/off the date/time display
Set [DATE/TIME] to [ON], [AUTO] or [OFF].
(pg. 48, 49)

To turn on/off the on-screen display / To check the file information (pg. 38)
Press **INFO/** repeatedly.

NOTES:

- Images shot and stored on the recording media with another device may not be played back correctly.
- You can zoom in/out or rotate still images. (pg. 30)

Slide Show

You can playback all the images stored in recording media automatically.

- 1 Set the power switch to .
- 2 Set the **MODE** switch to .
 - A still image is displayed.
 - To switch the medium to be played back, see pages 21, 48 and 49.
- 3 Press to start the slide show.
 - If you press during the slide show, files are displayed in descending order.
 - If you press during the slide show, files are displayed in ascending order.
 - To end the slide show, press again.

To display the next image

To display the previous image

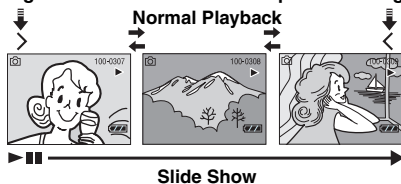

Index Screen of Still Image Files

You can view multiple files stored in a recording medium at a time. This browsing capability makes it easy to locate a particular file you want.

- 1 Slide the zoom lever to **W** when a recorded image is displayed.
 - The display switches to the index screen.
- 2 Press / / / to move the frame to the desired file.
- 3 Press . The selected file is displayed.



How to Use the Scroll Bar

You can use the vertical scroll bar on the index screen to find the desired files quickly. The scroll bar is useful when deleting files (pg. 39), setting DPOF (pg. 46), etc.

1 Slide the zoom lever towards **W** to select the scroll bar on the index screen.

2 Press \wedge/\vee to display the next or previous page.

- If you press and hold \wedge/\vee , the high speed search starts.
- If you find the desired file, slide the zoom lever towards **T**, then select the file.

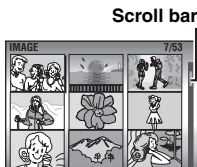

Date Index Screen

You can also find the desired file by the date index screen. The files are sorted according to their recorded date.

1 Perform step **1** in "Index Screen of Still Image Files" (pg. 29) to display the index screen.

2 Slide the zoom lever twice towards **W**. The date index screen appears.

3 Press \wedge/\vee to select the desired date. The files recorded on the selected date are displayed on the right side of the screen.

- Dates can also be selected by using the scroll bar on the right side of the screen. To select the scroll bar, slide the zoom lever towards **W** while on the date index screen, and press \wedge/\vee .

4 Press \blacktriangleright . The files recorded on the selected date are displayed in the index screen.

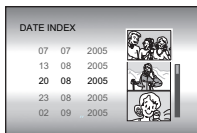

Image Rotation

You can rotate a still image clockwise or counterclockwise.

- 1** Set the power switch to \blacktriangleright .
- 2** Set the **MODE** switch to CAM .
 - A still image is displayed.
 - To switch the medium to be played back, see pages 21, 48 and 49.
- 3** Press \vee to rotate 90° clockwise.
 - Each time you press \vee , the image rotates clockwise. (90° → 180° → 270° → 0°)
- 4** Press \wedge to rotate 90° counterclockwise.
 - Each time you press \wedge , the image rotates counterclockwise. (270° → 180° → 90° → 0°)

Playback Zoom

You can magnify the playback image up to 5x.

- 1** Set the power switch to \blacktriangleright .
- 2** Set the **MODE** switch to CAM .
 - A still image is displayed.
 - To switch the medium to be played back, see pages 21, 48 and 49.
- 3** Slide the zoom lever towards **T** to zoom in.
 - The full view of the image is displayed in the small screen on the lower right side. The C mark indicates the centre point of the magnified area.
- 4** Press $\wedge/\vee/\langle/\rangle$ to move to the magnified area you want to view.
- 5** To zoom out, slide the zoom lever towards **W**.
 - When the zoom is set all the way to **W** (wide-angle) side, sliding the zoom lever to **W** switches the display to the index screen. (pg. 29)

Deleting Still Image Files

Press DEL , then press \wedge/\vee to select [EXECUTE] and press \blacktriangleright .

- You can select the desired file to be deleted by pressing \langle/\rangle .
- To delete multiple files at once, see page 39.

Backlight Compensation



Backlight compensation brightens the subject quickly. With simple operation, dark portions of the subject are brightened by increasing the exposure.

- 1 Set the power switch to .
- 2 Press and hold \triangleright (A/M) so that M is displayed.
- 3 Press \wedge (Z) once so that the indicator appears.

To cancel backlight compensation

Press \wedge (Z) twice so that the indicator disappears.

Spot Exposure Control



Selection of a spot metering area enables more precise exposure compensation. You can select one of the three metering areas.

- 1 Set the power switch to .
- 2 Press and hold \triangleright (A/M) so that M is displayed.
- 3 Press \wedge (Z) twice so that the indicator appears.
 - The spot metering area frame () appears at the centre.
- 4 Press \langle / \rangle to select the desired spot metering area frame.
- 5 Press \blacktriangleright . The setting is completed.

To lock the exposure

After step 4, press and hold \blacktriangleright for over 2 seconds. The indicator appears.

To cancel spot exposure control

Press \wedge (Z) once so that the indicator disappears.

NOTES:

- Spot exposure control may not be possible when some other functions are activated.
- Depending on the shooting location and condition, optimum result may not be attained.

Flash



You can use the flash for still image recording. The flash mode can be changed as required.

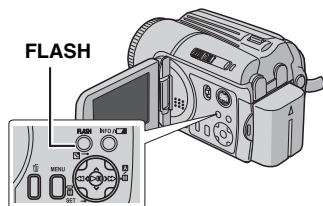

- 1 Set the power switch to .
- 2 Set the MODE switch to .
- 3 Press **FLASH** repeatedly to select the desired flash mode.

- The selected mode indicator will be displayed on the screen.

⚡ A [AUTO]: The flash fires automatically when the surroundings are dark.

⚡ A AUTO RED-EYE: The flash fires automatically but reduces the red-eye phenomenon of the subject's eyes.

⚡ ON: The flash fires regardless of the shooting condition.

⚡ S SLOW SYNCHRO: The flash fires regardless of the shooting condition. The shutter speed becomes slower in this mode, so the background can also be brightened.

[] = Factory-preset

When not using the flash

Press **FLASH** repeatedly until no flash mode indicator is displayed on the screen.

NOTES:





- The flash and the continuous shooting cannot be used at the same time. The unusable mode indicator blinks or goes out.
- The flash mode indicator also blinks while charging the flash.
- If the flash mode is selected before turning the LCD monitor, you can continue to use the flash after the LCD monitor is turned 180°, even though the flash mode indicator will disappear. The flash mode cannot be selected after the LCD monitor is turned 180°. (⇨ pg. 9)
- If the flash is not bright enough, set [GAIN] to [AUTO] or [160]. (⇨ pg. 51) Alternatively, set [S.SP] to [NIGHTSCOPE] in the MSET menu. (⇨ pg. 35)

Manual Settings in MSET Menu



You can use manual recording functions easily by selecting items in the MSET menus.

How to Select a Menu Item

- 1 Set the power switch to .
- 2 Press and hold \triangleright () so that  is displayed.
- 3 Press \sphericalangle (). The menu screen appears.
- 4 Press \langle / \rangle to select a desired item from the MSET menu, then press **▶II**.

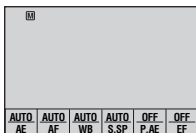

There are 6 items in the MSET menu.

AE: Manual Exposure ([⇨ pg. 32](#))

AF: Manual Focus ([⇨ pg. 33](#))

WB: White Balance ([⇨ pg. 34](#))

S.SP: Shutter Speed ([⇨ pg. 35](#))

P.AE: Program AE ([⇨ pg. 36](#))

EF: Effect ([⇨ pg. 36](#))

Step 5 and 6 below are example of the manual exposure setting.

- 5 Press \langle / \rangle to select a setting, then press **▶II**. The setting is completed.

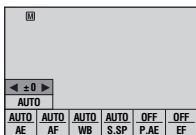

- 6 Press \sphericalangle () to close the MSET menu.

NOTE:

While recording is in progress, [S.SP], [P.AE] and [EF] cannot be set even if \sphericalangle () is pressed.

Manual Exposure

Manual exposure is recommended in the following situations:

- When shooting using reverse lighting or when the background is too bright.
- When shooting on a reflective natural background such as at the beach or when skiing.
- When the background is overly dark or the subject is bright.

1 Select [AE] in the MSET menu. ([⇨ pg. 32](#))

2 If [AUTO] is selected, press \wedge . (video mode only)

3 To brighten the image, press \triangleright . To darken the image, press \triangleleft .

• Adjustment range

For video recording: -6 to +6 or AUTO (automatic exposure)

For still image recording: -2.0 to +2.0 (EV)

4 Press **▶II**. The setting is completed.

5 Press \sphericalangle () to close the MSET menu.

To lock the exposure

After step **5**, press and hold **▶II** for over 2 seconds. The  indicator appears.

NOTES:

- You cannot use the manual exposure at the same time when [P.AE] is set to [SPOTLIGHT] or [SNOW] ([⇨ pg. 36](#)), or with backlight compensation ([⇨ pg. 31](#)).
- If the adjustment does not make any visible change in brightness, set [GAIN UP] to [ON] when recording videos ([⇨ pg. 50](#)), or set [GAIN] to [AUTO] when recording still images ([⇨ pg. 51](#)).

Manual Focus

The camera's Full Range AF system offers continuous focusing ability from close-up to infinity. However, the correct focus may not be obtained depending on the shooting condition. In this case, use the manual focus mode.

1 Select [AF] in the MSET menu. (⇒ pg. 32)

2 If [AUTO] is selected, press \wedge , then press \blacktriangleright .

3 Press \blacktriangleright to focus on a nearer subject.

(\blacktriangle \blacktriangleright \blacktriangle)

Press \blacktriangleleft to focus on a further subject.

(\blacktriangle \blacktriangleleft \blacktriangle)

- When the focus level cannot be adjusted any further or nearer, \blacktriangle or \blacktriangle will blink.



Focusing on a further subject



Focusing on a nearer subject

To return to automatic focus

Select [AUTO] in step **2**.

Manual focus is recommended in situations listed below:

- When two subjects overlap in the same scene.
 - When illumination is low.*
 - When the subject has no contrast (difference in brightness and darkness), such as a flat, one-colour wall, or a clear, blue sky.*
 - When a dark object is barely visible in the display.*
 - When the scene contains minute patterns or identical patterns that are regularly repeated.
 - When the scene is affected by sunbeams or light reflecting off the surface of a body of water.
 - When shooting a scene with a high-contrast background.
- * The following low-contrast warnings appear blinking: \blacktriangle , \blacktriangleleft , \blacktriangleright , and \blacktriangle .

White Balance

The white balance is usually adjusted automatically for correctness of the colour reproduction under various lighting. However, you can also select the following modes according to the shooting situations.

1 Select [WB] in the MSET menu. (⇨ pg. 32)

2 Press \wedge/\vee to select the desired mode.

 **MWB**: For adjusting the white balance manually depending on the light source.

⇨ "Manual White Balance Adjustment"
(⇨ pg. 34)

 **FINE**: When shooting outdoors on a sunny day.

 **CLOUD**: When shooting outdoors on a cloudy day.

 **HALOGEN**: When a video light or similar type of lighting is used.

3 Press \blacktriangleright until the setting is completed.

4 Press \vee (\square MSET) to close the MSET menu.

To return to automatic white balance

Select [AUTO] in step **2**.

Manual White Balance Adjustment

1 Select [MWB] in WB menu. (⇨ pg. 34)

2 Hold a sheet of plain white paper in front of the subject. Adjust zoom or position yourself so that the white paper fills the screen.

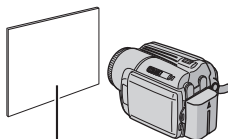

White paper

3 Press and hold \blacktriangleright until  indicator begins blinking then stops blinking.

NOTES:

- In step **2**, it may be difficult to focus on the white paper. In such a case, adjust with manual focusing. (⇨ pg. 33)
- A subject can be shot under various types of lighting conditions indoors (natural, fluorescent, candlelight, etc.). Because the colour temperature is different depending on the light source, the subject tint will differ depending on the white balance settings. Use this function for a more natural result.
- Once you adjust white balance manually, the setting is retained even if the power is turned off or the battery is removed.

Shutter Speed

You can set the shutter speed manually. A fast shutter speed can freeze the motion of a fast-moving subject and a slow shutter speed can blur the subject to give the impression of motion.



1 Select [S.SP] in the MSET menu. (▶ pg. 32)

2 If [AUTO] is selected, press \wedge .

3 Press \langle / \rangle to select the desired shutter speed. The shutter speed is displayed.

You can select the shutter speed from the followings.

- If you cannot change the value, press \blacktriangleright II.

NIGHTSCOPE	The shutter speed is fixed at 1/2 second. This enables shooting with little light in dim locations. The  indicator appears.
1/4 1/8 1/15 1/30	Slow shutter speed can blur the subject to give the impression of flowing motion.
1/50	The shutter speed is fixed at 1/50 second. Black bands that usually appear when shooting a TV screen become narrower.
1/120	The shutter speed is fixed at 1/120 second. The flickering that occurs when shooting under a fluorescent light or mercury-vapor lamp is reduced.
1/250 1/500 1/1000* 1/2000* 1/4000*	Fast shutter speed allows fast-moving subject to be captured one frame at a time vividly. Use these settings when an automatic adjustment does not work well by  (SPORTS) mode in Program AE. (▶ pg. 36)

* Not available for still image recording.

4 Press \blacktriangleright II. The setting is completed.

To change the shutter speed

Press \blacktriangleright II, then select the shutter speed by pressing \langle / \rangle and press \blacktriangleright II.

To return to automatic shutter speed

Select [AUTO] in step 3.

NOTES:

- It is recommended to use a tripod when recording with a slow shutter speed.
- The shutter speed can be set separately in video and still image.

Program AE

You can use the program AE settings for specific shooting situations.

1 Select [P.AE] in the MSET menu. (→ pg. 32)

2 Press \wedge / \vee to select the desired mode.

 **TWILIGHT**: Makes evening scenes look more natural.

 **SPOTLIGHT**: The subject in the front is accentuated by blurring the background.

 **SPORTS**: Fast shutter speed allows fast-moving subject to be captured one frame at a time vividly. The shutter speed is set at 1/250 to 1/4000 second automatically.

 **SNOW**: Compensates for subjects that may appear too dark when shooting in extremely bright surroundings such as in the snow.

3 Press \blacktriangleright II. The setting is completed.

To turn off the program AE function

Select [OFF] in step **2**.

Effect

You can record videos or still images with special effects.

1 Select [EF] in the MSET menu. (→ pg. 32)

2 Press \wedge / \vee to select the desired mode.

 **SEPIA**: The image has a brownish tint like old photos.

B/W **MONOTONE**: The image becomes black and white like old movies.

 **CLASSIC FILM***: The image has an old movie atmosphere by the effect of skipping frames.

 **STROBE***: The image looks like a series of consecutive snapshots.

* Not available for still image recording.

3 Press \blacktriangleright II. The setting is completed.

4 Press \vee (MSET) to close the MSET menu.











To turn off the effect

Select [OFF] in step **2**.

Wipe or Fader Effects



You can view videos with various effects of scene transition.

- 1 Set the power switch to .
- 2 Set the **MODE** switch to .
- 3 Press **MENU**. The menu screen appears.
- 4 Press \wedge/\vee to select [WIPE/FADER], then press **▶II**.
- 5 Press \wedge/\vee to select a desired effect.
 -  **FADER-WHITE**: Fade in or out with a white screen.
 -  **FADER-BLACK**: Fade in or out with a black screen.
 -  **FADER-B.W**: Fade in to a colour screen from a black and white screen, or fade out from colour to black and white.
 -  **WIPE:CORNER**: Wipe in on a black screen from the upper right to the lower left corner, or wipe out from lower left to upper right, leaving a black screen.
 -  **WIPE:WINDOW**: The scene starts in the centre of a black screen and wipes in toward the corners, or comes in from the corners, gradually wiping out to the centre.
 -  **WIPE:SLIDE**: Wipe in from right to left, or wipe out from left to right.
 -  **WIPE:DOOR**: Wipe in as the two halves of a black screen open to the left and right, revealing the scene, or wipe out and the black screen reappears from left and right to cover the scene.
 -  **WIPE:SCROLL**: The scene wipes in from the bottom to the top of a black screen, or wipes out from top to bottom, leaving a black screen.
 -  **WIPE:SHUTTER**: Wipe in from the centre of a black screen toward the top and bottom, or wipe out from the top and bottom toward the centre leaving a black screen.
- 6 Press **▶II**. The setting is completed.
- 7 Press **MENU** to close the menu screen.
 - The selected wipe or fader effect works when playback starts and ends.







To turn off the effect

Select [OFF] in step 5.

Playback Effects



You can view videos or still images with special image effects.

- 1 Set the power switch to .
- 2 Set the **MODE** switch to  or .
- 3 Press **MENU**. The menu screen appears.
- 4 Press \wedge/\vee to select [EFFECT], then press **▶II**.
- 5 Press \wedge/\vee to select a desired effect.
 -  **SEPIA**: The image has a brownish tint like old photos.
 - B/W **MONOTONE**: The image becomes black and white like old movies.
 -  **CLASSIC FILM***: The image has an old movie atmosphere by the effect of skipping frames.
 -  **STROBE***: The image looks like a series of consecutive snapshots.
- * Not available for still image recording.
- 6 Press **▶II**. The setting is completed.
- 7 Press **MENU** to close the menu screen.

To turn off the effect

Select [OFF] in step 5.

Viewing File Information

You can view the file information in playback mode.

Information on Video Files

Press **INFO**/ while video playback is paused. File information appears.

FILE: File name

FOLDER: Folder name

DATE/TIME: Date and time of the recording

PB TIME: Playback time (length of the file)

QUALITY: Image quality (⇄ pg. 50)

PROTECT: File protection status (⇄ pg. 38)

- If you press **INFO**/ on the index screen (⇄ pg. 25), information on the selected file is displayed.

To turn off the file information display

Press **INFO**/ repeatedly.

Information on Still Image Files

Press **INFO**/ while a still image is displayed. File information appears.

FILE: File name

FOLDER: Folder name

DATE/TIME: Date and time of the recording

SIZE: Image size (⇄ pg. 51)

QUALITY: Image quality (⇄ pg. 51)

PROTECT: File protection status (⇄ pg. 38)

- If you press **INFO**/ on the index screen (⇄ pg. 29), information on the selected file is displayed.

To turn off the file information display

Press **INFO**/ repeatedly.

Protecting Files

You can protect files from the accidental erasure.

- 1 Set the power switch to .
- 2 Select the file type (video or still image) using the **MODE** switch.
- 3 Press **MENU**. The menu screen appears.
- 4 Press \wedge / \vee to select [PROTECT], then press **▶II**.

To protect the currently displayed file

- 5 Press \wedge / \vee to select [CURRENT], then press **▶II**.
- 6 Press \wedge / \vee to select [EXECUTE], then press **▶II**.
 - You can select the previous or next file by pressing \langle / \rangle .
 - To release protection, select the protected file, then perform step **5** and **6**.

To protect by selecting multiple files

- 5 Press \wedge / \vee to select [FILE SELECT], then press **▶II**.
 - The index screen appears.
- 6 Press $\wedge / \vee / \langle / \rangle$ to select the file you want to protect, then press **▶II**.
 - The  mark appears on the file.
 - To protect other files, repeat step **6**.
 - The scroll bar can also be used with the zoom lever and pressing \wedge / \vee . (⇄ pg. 25, 30)
 - If you slide the zoom lever towards **T**, the preview screen is displayed. Sliding the zoom lever towards **W** returns to the index screen.

- 7 Press **MENU**.

- 8 Press \wedge / \vee to select [QUIT], then press **▶II**.
 - The selected files are protected.
 - To release protection, select the protected file in step **6**.

To protect all files

5 Press \wedge / \vee to select [PROTECT ALL], then press **▶II**.

6 Press \wedge / \vee to select [EXECUTE], then press **▶II**.

- All files are protected.

To release protection of all files

5 Select [CANCEL ALL], then press **▶II**.

6 Press \wedge / \vee to select [EXECUTE], then press **▶II**.

CAUTION:

Do not remove the recording medium or perform any other operation (such as turning off the power) during protection. Also, be sure to use the provided AC adapter, as the data on the recording medium may be corrupted if the battery becomes exhausted during protection. If the data on the recording medium becomes corrupted, format it. (⇨ pg. 20)

Deleting Files

You can delete unnecessary files.

Deleting by the ⏏ Button

1 Set the power switch to ▶ .

2 Select the file type (video or still image) using the **MODE** switch.

3 Press \wedge / \vee / \langle / \rangle to display the desired file, then press ⏏ .

- You can also select the file on the index screen. (⇨ pg. 25, 29)

4 Press \wedge / \vee to select [EXECUTE], then press **▶II**.

NOTE:

If you press ⏏ during recording mode, the file recorded most recently will be deleted. However, if the recording mode (video or still image) is switched or the power is turned off and on again after recording, you cannot delete the file.

Deleting on the Menu Screen

1 Set the power switch to ▶ .

2 Select the file type (video or still image) using the **MODE** switch.

3 Press **MENU**. The menu screen appears.

4 Press \wedge / \vee to select [DELETE], then press **▶II**.

To delete the currently displayed file

5 Press \wedge / \vee to select [CURRENT], then press **▶II**.

6 Press \wedge / \vee to select [EXECUTE], then press **▶II**.

- You can select the previous or next file by pressing \langle / \rangle .

To delete by selecting multiple files

5 Press \wedge/\vee to select [FILE SELECT], then press \blacktriangleright **II**.

- The index screen appears.

6 Press $\wedge/\vee/</>$ to select the file you want to delete, then press \blacktriangleright **II**.

- To select other files, repeat step **6**.
- The scroll bar can also be used with the zoom lever and pressing \wedge/\vee . (☞ pg. 25, 30)
- If you slide the zoom lever towards **T**, the preview screen is displayed. Sliding the zoom lever towards **W** returns to the index screen.

7 Press **MENU**.

8 Press \wedge/\vee to select [EXECUTE AND QUIT], then press \blacktriangleright **II**.

- The selected files are deleted.

To delete all files

5 Press \wedge/\vee to select [DELETE ALL], then press \blacktriangleright **II**.

6 Press \wedge/\vee to select [EXECUTE], then press \blacktriangleright **II**.

- To cancel deletion, select [CANCEL], then press \blacktriangleright **II**.

NOTES:

- Protected files cannot be deleted. To delete them, release protection first. (☞ pg. 39)
- Once files are deleted, they cannot be restored. Check files before deleting.

CAUTION:

Do not remove the recording medium or perform any other operation (such as turning off the power) during deletion. Also, be sure to use the provided AC adapter, as the recording medium may be corrupted if the battery becomes exhausted during deletion. If the recording medium becomes corrupted, format it. (☞ pg. 20)

Cleaning Up a Recording Medium

Writing speed of recording media tends to become slow after long period of repeated use. To regain the speed, execute cleanup periodically. The cleanup function is equivalent to "Defragmentation" of PC's function.

NOTES:

- Make sure to use the provided AC adapter for the power supply when cleaning up a recording medium. (☞ pg. 16)
- It is recommended to run check disk regularly on the PC, on condition that there is no data on the hard disk of the camera.

1 Set the power switch to \square or \bullet .

2 Press **MENU**. The menu screen appears.

3 Press \wedge/\vee to select [REC MEDIA SETTING], then press \blacktriangleright **II**.

4 Press \wedge/\vee to select [CLEAN UP], then press \blacktriangleright **II**.

5 Press \wedge/\vee to select [HDD] or [SD], then press \blacktriangleright **II**.

- If the AC adapter is not connected to the camera, a warning message appears. In this case, connect the AC adapter.

6 Press \wedge/\vee to select [EXECUTE], then press \blacktriangleright **II**.

- To cancel cleanup, select [CANCEL], then press \blacktriangleright **II**.

7 When cleanup is finished, [CLEANING UP COMPLETED] appears. Press \blacktriangleright **II** to complete the operation.

- Depending on the hard disk drive it may take several minutes for this process to be completed.

CAUTION:

Do not remove the recording medium or perform any other operation (such as turning off the power) during cleanup.

Copying/Moving Still Image Files



You can copy or move still image files between the built-in hard disk (HDD) and SD card using the on-screen display.

Before proceeding to following steps,

- Make sure that SD card is inserted in the SD slot.
- Make sure that enough free space is left in the copy/move destination medium.

- 1** Set the power switch to or .
- 2** Press **MENU**. The menu screen appears.
- 3** Press \wedge/\vee to select [REC MEDIA SETTING], then press **▶**.
- 4** Press \wedge/\vee to select [COPY/MOVE], then press **▶**.
- 5** Press \wedge/\vee to select [COPY] or [MOVE], then press **▶**.

COPY: Files are copied to the destination medium while leaving original files in the source medium.

MOVE: Files are moved to the destination medium while deleting original files (except read-only files) in the source medium.

- 6** Press \langle/\rangle to select the direction of copy/move, then press \vee . (HDD \rightarrow SD or SD \rightarrow HDD)

To copy or move by selecting files

- 7** Press \langle/\rangle to select [FILE], then press **▶**.
 - The index screen appears.
- 8** Press $\wedge/\vee/\langle/\rangle$ to select a desired file, then press **▶**.
 - The check mark (\blacktriangledown) appears on the selected file.
 - To select other files, repeat this step.
 - The scroll bar can also be used with the zoom lever and \wedge/\vee . (pg. 30)
- 9** Press **MENU** to return to the previous screen.
- 10** Press \wedge/\vee to select [EXECUTE], then press **▶**.

11 File transfer starts.

- To stop the file transfer, press **▶**, then select [EXECUTE] and press **▶**.



- 12** When [COPYING (MOVING) COMPLETED] appears, press **▶** to finish the operation.

To copy or move all still image files in the recording medium

- 7** Press \langle/\rangle to select [ALL].
- 8** Press \wedge/\vee to select [EXECUTE], then press **▶**.
 - If you want to cancel, select [CANCEL], then press **▶**.
- 9** File transfer starts.
 - To stop the file transfer, press **▶**, then select [EXECUTE] and press **▶**.
- 10** When [COPYING (MOVING) COMPLETED] appears, press **▶** to finish the operation.



Resetting the File Number

By resetting the file number (name), a new folder will be made. The new files you are going to make will be stored in the new folder. It is convenient to separate the new files from previously recorded files.

- 1** Set the power switch to  or .
 - 2** Press **MENU**. The menu screen appears.
 - 3** Press \wedge/\vee to select [REC MEDIA SETTING], then press **▶II**.
 - 4** Press \wedge/\vee to select [NO. RESET], then press **▶II**.
 - 5** Press \wedge/\vee to select the file type (video or still image), then press **▶II**.
 - 6** Press \wedge/\vee to select [EXECUTE], then press **▶II**.
 - 7** Press **▶II**.
- The new folder (such as [101JVCSO]) will be made and the file number will start again from the new number (such as "PIC_0001.JPG").

Creating Play List

You can create a play list by collecting the desired scenes from the previously recorded video files.

- 1** Set the power switch to .
- 2** Set the **MODE** switch to .
- 3** Press **MENU**. The menu screen appears.
- 4** Press \wedge/\vee to select [PLAYLIST], then press **▶II**.
- 5** Press \wedge/\vee to select [EDIT], then press **▶II**.
- 6** Press \wedge/\vee to select [NEW LIST], then press **▶II**.
- 7** Press \wedge/\vee to scroll upward or downward the thumbnail images of recorded files, and select a file to be added to a play list.
 - The scroll bar can also be used with the zoom lever and pressing \wedge/\vee . (☞ pg. 25)

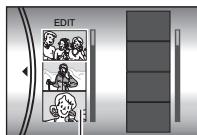

Thumbnail images of recorded files

- 8** Press **▶II**. The frame for selecting an inserting point appears.
- 9** Press \wedge/\vee to scroll upward or downward the thumbnail of images in a play list, and select a position where you want to insert the selected file.
 - The scroll bar can also be used with the zoom lever and pressing \wedge/\vee . (☞ pg. 25)
- 10** Press **▶II**. The selected file is added to a play list.
 - To add other files, repeat steps **7** to **10**.
- 11** Press **MENU**. The confirmation screen appears.
- 12** Press \wedge/\vee to select [SAVE AND QUIT], then press **▶II**.
 - To return to the edit screen, select [CANCEL].
 - If you do not want to save the play list, select [DELETE AND QUIT].

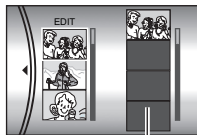

Play list

To check the play list by playing back the video

You can check the play list before saving it.

1 After step **10**, press **>** to select a thumbnail image of the play list.

2 Press **^/∨** to select a scene you want to check.

3 Press **▶II**. The playback of the play list starts from the selected scene.

- The playback stops at the end of the play list automatically.
- To stop playback midway, press **▶II**, then slide the zoom lever towards **W**.

To check only the scene transition

1 After step **10**, press **>** to select a scene transition.

- If a scene is selected, press **>** once more to select the scene transition bar.

2 Press **^/∨** to select a scene transition you want to check.

3 Press **▶II** to start playback of the selected scene transition.

To delete the added file from the play list

1 After step **10**, press **>** to select a thumbnail image of the play list.

2 Press **^/∨** to select the file you want to delete, then press **⏏**.

NOTES:

- You can display the play list menu simply by pressing the PLAYLIST button on the remote control.
- Maximum of 99 play lists can be created.
- Each play list can consist of maximum 99 scenes.
- If you delete the original files, the files are also deleted from the play list.
- Files in the [EXTMOV] folder cannot be used to create play lists.

Playing Back Play List



By playing back the play list, you can view your original video clips. (To create play list, [☞](#) pg. 42)

1 Set the power switch to **▶**.

2 Set the **MODE** switch to **Ⓜ**.

3 Press **MENU**. The menu screen appears.

4 Press **^/∨** to select [PLAYLIST], then press **▶II**.

5 Press **^/∨** to select [PLAYLIST CONTENTS], then press **▶II**. The table of play lists appears.

6 Press **^/∨** to select a list you want to play back.

(The display format of date and time differs depending on the country where this camera is sold.)

- The scroll bar can also be used with the zoom lever and pressing **^/∨**. ([☞](#) pg. 25)

7 Press **▶II** to start playback.

- During playback of play list, "P" mark appears on the top left corner of the screen.

• If you slide the zoom lever towards **W** while playback is paused, the index screen for play list appears. You can see the contents of the play list and select the desired scene. To return to playback screen, slide the zoom lever to **T**.

- You can use various playback functions during playback. ([☞](#) pg. 25)

8 To stop playback, press **▶II**.

- To return to the normal playback mode, select [ALL SCENES] in step **6**.





NOTE:

You can display the play list menu simply by pressing the PLAYLIST button on the remote control.





Add/Delete Files in Play List

You can edit existing play lists by adding or deleting files.

- 1** Set the power switch to .
- 2** Set the **MODE** switch to .
- 3** Press **MENU**. The menu screen appears.
- 4** Press \wedge/\vee to select [PLAYLIST], then press **▶II**.
- 5** Press \wedge/\vee to select [EDIT], then press **▶II**.
- 6** Press \wedge/\vee to select the play list you want to edit, then press **▶II**.
 - To add or delete files, follow the steps **7** to **12** in “Creating Play List” ( pg. 42), or **1** to **2** in “To delete the added file from the play list” ( pg. 43).



Changing Play List Name

The default name of play list is its creation date and time. You can change the name on the keyboard screen as you like.

- 1** Set the power switch to .
- 2** Set the **MODE** switch to .
- 3** Press **MENU**. The menu screen appears.
- 4** Press \wedge/\vee to select [PLAYLIST], then press **▶II**.
- 5** Press \wedge/\vee to select [RENAME], then press **▶II**. The table of play lists appears.
- 6** Press \wedge/\vee to select a play list whose name you want to change.
 - The scroll bar can also be used with the zoom lever and pressing \wedge/\vee . ( pg. 25)
 - The thumbnail appears on the upper right side.
- 7** Press **▶II**. The keyboard screen appears.
- 8** Press $\wedge/\vee/\langle/\rangle$ to select the desired letter, then press **▶II**.
 - Repeat this process to complete the name.
 - You can change the character types (capital letters, small letters or marks) by selecting [A/a/@].
 - To correct a letter, select [\leftarrow] or [\rightarrow] and press **▶II** to move the cursor to the letter, then select [CLEAR] and press **▶II**.
- 9** Press $\wedge/\vee/\langle/\rangle$ to select [\leftarrow], then press **▶II**.
 - To cancel the setting, select [CANCEL], then press **▶II**.

Deleting Play List

You can delete unnecessary play lists.

- 1** Set the power switch to .
- 2** Set the **MODE** switch to .
- 3** Press **MENU**. The menu screen appears.
- 4** Press \wedge/\vee to select [PLAYLIST], then press **▶II**.
- 5** Press \wedge/\vee to select [DELETE], then press **▶II**. The table of play lists appears.
- 6** Press \wedge/\vee to select a play list you want to delete.
 - The thumbnail appears on the upper right side.
 - To delete all play lists at once, select [DELETE ALL].
- 7** Press **▶II**.
- 8** Press \wedge/\vee to select [EXECUTE], then press **▶II**. The selected play list is deleted.
 - To cancel the setting, select [CANCEL], then press **▶II**.
 - Original files are not deleted even if you delete the play list.

Dubbing Using Play List

Dubbing to an external device (VCR, DVD recorder etc.) using a play list is possible. The following explains how to dub to a VCR, but the same steps also apply for a DVD recorder, etc.

- 1** Connect the camera and your VCR with the S/AV cable. (☞ pg. 26)
- 2** Set the VCR to VIDEO/AUXILIARY input and engage the recording standby mode.
 - For details on how to set VIDEO/AUXILIARY input, refer to VCR instructions.
- 3** Set the power switch to .
- 4** Set the **MODE** switch to .
- 5** Press **MENU**. The menu screen appears.
- 6** Press \wedge/\vee to select [PLAYLIST], then press **▶II**.
- 7** Press \wedge/\vee to select [PLAYLIST CONTENTS], then press **▶II**. The table of play lists appears.
- 8** Press \wedge/\vee to select a list you want to dub.
 - The scroll bar can also be used with the zoom lever and pressing \wedge/\vee . (☞ pg. 25)
- 9** Press \gt . Screen for dubbing appears.
- 10** Press \wedge/\vee to select [START PLAYBACK], then press **▶II**. Playback on the camera starts.
 - The black screen is displayed for 5 seconds at the beginning and the end of the play list playback.
 - To cancel the setting, press \wedge/\vee to select [CANCEL], then press **▶II**.
- 11** While the black screen is displayed for 5 seconds, start recording on the VCR. (Refer to your VCR's instruction manual.)
- 12** To stop dubbing, stop recording on the VCR while the black screen is displayed for 5 seconds.

DPOF Print Setting



This camera is compatible with DPOF (Digital Print Order Format). You can set which images to be printed and the number of prints with this camera. This feature is useful to print with a DPOF-compatible printer or bring a recording medium to photo lab for print.

To print by selecting a still image

- 1 Set the power switch to .
- 2 Set the **MODE** switch to .
- 3 Press **MENU**. The menu screen appears.
- 4 Press \wedge/\vee to select [DPOF], then press **▶II**. The DPOF menu screen appears.
- 5 Press \wedge/\vee to select [SELECT IMAGES], then press **▶II**.

6 Press $\wedge/\vee/\langle/\rangle$ to select the desired file, then press **▶II**.

- The scroll bar can also be used with the zoom lever and pressing \wedge/\vee . (☞ pg. 30)
- If you slide and hold the zoom lever towards **T**, the preview screen of the still image is displayed.

7 Press \langle/\rangle to select the number of prints (max. 15 prints), then press **▶II**.

- To set print information for other images, repeat steps **6** and **7**.

8 Press **MENU** to finish the setting.

- To cancel the selection, select the same image in step **6**.

NOTES:

- The DPOF setting is available up to 999 images.
- DPOF printing can only be specified for still images stored on the SD card. To specify still images stored on the hard disk, you must first copy the image files onto the SD card before setting printing. (☞ pg. 41)
- The date index function cannot be used.

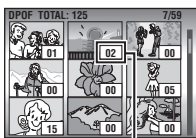
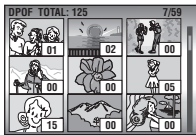

Number of prints

To print all still images (One print for each)

- 1 Display the DPOF menu screen. (☞ “To print by selecting a still image”)
- 2 Press \wedge/\vee to select [ALL1], then press **▶II**.
- 3 Press \wedge/\vee to select [EXECUTE], then press **▶II**.
- 4 Press **MENU** to finish the setting.

To confirm the DPOF setting

- 1 Display the DPOF menu screen. (☞ “To print by selecting a still image”)
- 2 Press \wedge/\vee to select [CHECK SETTINGS], then press **▶II**.
- 3 If necessary, change the number of prints for the desired file by following the steps **6** to **7** in “To print by selecting a still image”.
- 4 Press **MENU** to return to the previous menu.

To reset the DPOF setting

- 1 Display the DPOF menu screen. (☞ “To print by selecting a still image”)
- 2 Press \wedge/\vee to select [RESET], then press **▶II**.
- 3 Press \wedge/\vee to select [EXECUTE], then press **▶II**.
- 4 Press **▶II** to finish the reset.

Direct Printing with a PictBridge Printer

If your printer is compatible with PictBridge, still images can be printed easily by connecting the camera with the USB cable directly to the printer. DPOF setting can also be used.

(pg. 46)

NOTE:

After selecting [DIRECT PRINT] in the menu, connect the USB cable.

To print by selecting a still image

- 1 Set the power switch to .
- 2 Set the **MODE** switch to .
- 3 Press **MENU**. The menu screen appears.
- 4 Press \wedge/\vee to select [DIRECT PRINT], then press **▶II**. A message [PLEASE CONNECT PRINTER] appears.
- 5 Connect the camera to the printer with the USB cable.
 - After a while, the print menu appears.
- 6 Press \wedge/\vee to select [SELECTED PRINT], then press **▶II**.
- 7 Press \langle/\rangle to select the desired file, then press **▶II**.
- 8 Press \langle/\rangle to set the number of prints.
 - The number of prints can be set from 1 to 99.
- 9 Press \wedge/\vee to select [DATE], then press \langle/\rangle to select [ON] or [OFF].
 - Select [ON] to print the date or [OFF] not to print.
- 10 Press \wedge/\vee to select [PRINT], then press **▶II**. The image is printed.

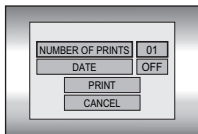

To cancel print setting

Press \wedge/\vee to select [CANCEL], then press **▶II**.

To stop printing after printing starts

- 1 Press **▶II**. The confirmation screen appears.
- 2 Press \wedge/\vee to select [EXECUTE], then press **▶II**.

To print using the DPOF setting

If the printer is compatible with DPOF, you can use the DPOF setting. (pg. 46)

- 1 Set the power switch to .
- 2 Set the **MODE** switch to .
- 3 Press **MENU**. The menu screen appears.
- 4 Press \wedge/\vee to select [DIRECT PRINT], then press **▶II**. A message [PLEASE CONNECT PRINTER] appears.
- 5 Connect the camera to the printer with the USB cable.
 - After a while, the print menu appears.
- 6 Press \wedge/\vee to select [DPOF PRINT], then press **▶II**.
- 7 Press \wedge/\vee to select [PRINT], then press **▶II**. The images are printed.
 - To confirm the DPOF setting, press \wedge/\vee to select [CHECK SETTINGS], then press **▶II**. After that, press **MENU** to return to the previous menu.

NOTE:

If the printer is not recognised, or to print again after direct printing with a PictBridge printer, remove the USB cable, select [DIRECT PRINT] in the menu again, and then reconnect the cable.

Changing the Menu Settings

You can change the menu settings to customize your camera. Access the desired menu screen by following the steps below, then change the various settings.

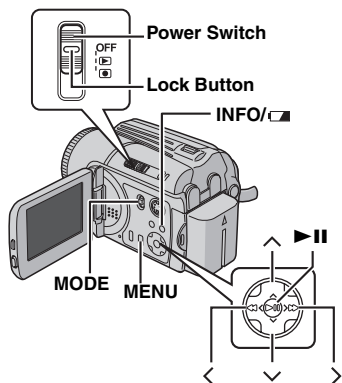

1 Select the operation mode.

For Recording Menus:

Set the power switch to

For Playback Menus:

Set the power switch to

2 Select (video) or (still image) using the **MODE** switch.

3 Press **MENU**. The menu screen appears.

4 Select the desired sub menu and menu item with / and .

- To return to the normal screen, press **MENU**.
- To display the operation guide, press **INFO/OK** when the menu screen is displayed. (The operation guide is not displayed depending on the type of the menu.) To remove the operation guide, press **INFO/OK** again.
- Even if the menu item is displayed, some item cannot be set depending on the selected mode (video/still image, recording/playback). In this case, sub menu cannot be accessed or setting cannot be changed.

Common Menus for All Modes

[] = Factory-preset

BASIC SETTING

PRESET

EXECUTE: Resets all settings to the factory-preset.

[CANCEL]: Returns to the menu screen without executing reset.

DEMO MODE

OFF: Disables the function.

[ON]: Activates demonstration mode and shows various features on the display.

Demonstration starts in the following cases:

- When the menu screen is closed after [DEMO MODE] is set to [ON].
- With [DEMO MODE] set to [ON], if there is no operation for about 3 minutes after the power switch is set to .
- Performing any operation during the demonstration stops the demonstration temporarily. If no operation is performed for more than 3 minutes after that, the demonstration will resume.

NOTES:

- Demonstration only works with DC cord connected, not with battery.
- If an SD card is in the camera, demonstration will not take place even if it is set to [ON].
- [DEMO MODE] remains [ON] even if the camera power is turned off.

OPERATION SOUND

OFF: Turns off operation sound.

BEEP: The beep sounds when the power is turned on or off, and at the beginning and end of recording.

[MELODY]: Instead of a beep, a melody sounds when any operation is performed.

REMOTE

OFF: Makes the camera not to receive the signal from the remote control.

[ON]: Enables the operation with the remote control.

DROP DETECTION

OFF: Disables the function.

[ON]: Turns off the power automatically to prevent HDD damage when the camera is accidentally dropped. (☞ pg. 21)

CAUTION:

Setting this function to off increases the chances of damaging the internal hard disk if the camera is accidentally dropped.

❁ REC MEDIA SETTING

VIDEO MODE**[HDD] / SD****IMAGE MODE****[HDD] / SD**

Media selection can be set for each recording and playback mode: video (📹) or still image (📷).

HDD: The built-in hard disk is selected as a recording medium.

SD: SD card is selected as a recording medium.

FORMAT**[HDD] / SD**

You can format (initialise) the built-in hard disk or SD cards. (☞ pg. 20)

CLEAN UP**[HDD] / SD**

Writing speed of recording media tends to become slow after long period of repeated use. To regain the speed, execute cleanup periodically. (☞ pg. 40)

COPY/MOVE**[COPY] / MOVE**

You can copy or move still image files between the built-in hard disk and SD card. (☞ pg. 41)

NO. RESET**[VIDEO] / IMAGE**

By resetting the file number (name), a new folder will be made. The new files you are going to make will be stored in the new folder. (☞ pg. 42)

⊕ DISPLAY

BRIGHT

When this item is selected, the brightness control indicator appears. Adjust the brightness of the display using </>, then press ►II. (☞ pg. 18)

DATE/TIME

OFF: The date/time does not appear.

[AUTO]: Displays the date/time for approx. 5 seconds in the following cases.

- When the power switch is set from **OFF** to
- When playback starts
- When the date is changed during playback

ON: The date/time is always displayed.

NOTES:

- Only the date is displayed for the video playback.
- You can set to different setting for each mode (video recording/playback and still image recording/playback).

SCENE COUNTER

[OFF]: Disables the function.

ON: Displays the counter during video mode.

LANGUAGE

[ENGLISH] / FRANÇAIS / DEUTSCH / ESPAÑOL / ITALIANO / NEDERLANDS / РУССКИЙ

The language setting can be changed. (☞ pg. 17)

CLOCK ADJUST





☞ "Date/Time Settings" (☞ pg. 18)

Video Recording Menus

[] = Factory-preset

QUALITY

Select the desired picture quality.

Mode (In order of the quality)	Size (pixels)	Bit rate
 [ULTRA FINE]	720 x 576	8.5 Mbps
 FINE	720 x 576	5.5 Mbps
 NORMAL	720 x 576	4.2 Mbps
 ECONOMY	352 x 288	1.5 Mbps

WIDE MODE

[OFF]: Disables the function.

16:9 WIDE: For playback on TVs with an aspect ratio of 16:9. Naturally expands the image to fit the screen without distortion. The  indicator appears. When using this mode, refer to your wide-screen TV's instruction manual. During playback/recording on 4:3 TVs, black bands may be inserted at the top and bottom of the screen, or the image may appear to be slightly vertically stretched, due to the ratio change.

NOTES:

- The 16:9 WIDE mode cannot be used when using ECONOMY mode.
- Use software that supports wide display when playing videos that were recorded in 16:9 WIDE mode on a PC.

WIND CUT

[OFF]: Disables the function.

ON: Helps cut down on noise created by wind. The  indicator appears.

GAIN UP

OFF: The image in the dark will be recorded with no picture brightness adjustment.

[ON]: The image in the dark will be brightened. But the overall appearance may become grainy.

DIS

OFF: Disables the function.

[ON]: Compensates for unstable images caused by camera-shake, particularly at high magnification. The  indicator appears.

NOTES:

- Accurate stabilization may not be possible if hand shake is excessive, or depending on the shooting condition. In this case, the  indicator blinks or goes out.
- Switch off this mode when recording with the camera on the tripod.

CAMERA SETTING

ZOOM

10X: Only optical zoom is available up to 10x.

[40X]: Digital zoom is available up to 40x.

200X: Digital zoom is available up to 200x.

TELE MACRO

[OFF]: Disables the function.

ON: You can shoot a subject as large as possible at a distance of approx. 70 cm. The  indicator appears.

Video Playback Menus

[] = Factory-preset

PLAYLIST

[PLAYLIST CONTENTS] / EDIT / RENAME / DELETE

You can create a play list and view your original video clips. (⇨ pg. 42 – 45)

WIPE/FADER

⇨ "Wipe or Fader Effects" (⇨ pg. 37)

EFFECT

⇨ "Playback Effects" (⇨ pg. 37)

PROTECT

[CURRENT] / FILE SELECT / PROTECT ALL / CANCEL ALL

You can protect files from accidental erasure. (⇨ pg. 38)

DELETE

[CURRENT] / FILE SELECT / DELETE ALL

You can delete unnecessary files. (⇨ pg. 39)

Still Image Recording Menus

[] = Factory-preset

QUALITY

[FINE] / STANDARD

Select the desired image quality.



IMAGE SIZE

[1600 x 1200] / 1280 x 960 / 1024 x 768 /
640 x 480

Select the desired image size.

SELF-TIMER

[OFF] / 2SEC / 10SEC

By setting the self-timer, a still image is recorded 2 or 10 seconds after pressing recording start/stop button. The  or  indicator appears.

CONTINUOUS SHOOTING

[OFF]: Disables the function.

ON: You can record still images continuously.

The  indicator appears on the display.

( pg. 28)

GAIN

[AUTO] / 80 / 160

Select the ISO sensitivity to the desired setting. When set to [AUTO], the sensitivity automatically increases in dark conditions.

NOTE:

The amount of image noise increases as the setting level increases.

CAMERA SETTING

TELE MACRO

The menu item of TELE MACRO is the same as in the description on page 50.



Still Image Playback Menus

[] = Factory-preset

DPOF

 "DPOF Print Setting" ( pg. 46)

DIRECT PRINT

 "Direct Printing with a PictBridge Printer" ( pg. 47)

EFFECT

 "Playback Effects" ( pg. 37)

PROTECT

DELETE

The menu items of PROTECT and DELETE are the same as in the description on page 50.

Troubleshooting

The camera is a microcomputer-controlled device. External noise and interference (from a TV, a radio, etc.) might prevent it from functioning properly.

- To solve the problem, follow the Instructions below at first.
- If the problem is not solved, reset the camera. (Refer to "To reset the camera" below.)
- If the problem still exists, please consult your nearest JVC dealer.

■ To reset the camera

- ① Press **RESET** using a piece of wire or other such pointed instrument. The power is turned off once and turned on again automatically.

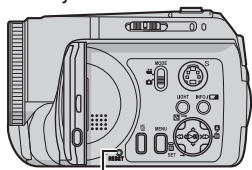

RESET

- ② If nothing happens, set the power switch to **OFF** and remove the power supply (battery pack or AC adapter) from the camera, then put it back again.
- ③ Execute [PRESET] from the menu. The camera returns to its factory-preset. (⇨ pg. 48)

Power

No power is supplied.

- The power is not connected properly.
- Connect the AC adapter securely. (⇨ pg. 14)
- The battery pack is not attached firmly.
- Detach the battery pack once again and re-attach it firmly. (⇨ pg. 14)
- The battery is dead.
- Replace the dead battery with a fully charged one. (⇨ pg. 14)

No display appears.

- When using the AC adapter, the camera enters the sleep mode, the access lamp lights, and the LCD monitor turns off.
- To cancel the sleep mode, perform any operation such as zooming.

The power was turned off accidentally.

- The drop detection function operated. (⇨ pg. 21)
- Set the power switch to **OFF**, and turn the power on again. To turn off the drop detection function, set [DROP DETECTION] to [OFF]. (⇨ pg. 49)

Recording

Recording cannot be performed.

- [MEMORY CARD IS FULL] appears.
- Replace with new recording medium or delete unnecessary files. (⇨ pg. 19, 39)
- Recording medium is not selected properly.
- Select the recording medium. (⇨ pg. 21, 48, 49)

When shooting a subject illuminated by bright light, vertical lines appear.

- This is not a malfunction.

When the screen is under direct sunlight during shooting, the screen becomes red or black for an instant.

- This is not a malfunction.

During recording, the date/time does not appear.

- [DATE/TIME] is set to [OFF].
- Set [DATE/TIME] to [ON]. (⇨ pg. 49)

The LCD monitor indications blink.

- Certain modes of program AE, effect, DIS and other functions that cannot be used together are selected at the same time.

Digital zoom does not work.

- [ZOOM] is set to [10X] (optical zoom).
- Set [ZOOM] to [40X] or [200X]. (⇨ pg. 50)
- Digital zoom is not available in the still image recording mode.

The recorded image is white

- Shutter speed is set to NIGHTSCOPE or slow speed.
- NIGHTSCOPE and slow speed are only for use in dark conditions. (⇨ pg. 35)

Playback**Playback cannot be performed.**

- Recording medium is not selected properly.
- Select the recording medium. (⇨ pg. 21, 48, 49)
- Playback starts, but there is no picture on the connected TV.
- Set the TV's input mode or channel appropriate for video playback.

The same image is displayed for a long time during video playback, or motion is choppy.

- If the surface of the SD card is damaged, it makes it difficult to read data and these phenomena will appear. This camera will make all possible efforts to read data, but when such a state continues for some time and further playback is impossible, it will stop automatically.
- It is recommended to run check disk regularly on the PC, on condition that there is no data on the hard disk of the camera.

Advanced features**The focus does not adjust automatically.**

- Focus is set to the manual mode.
- Set focus to the automatic mode. (⇨ pg. 33)
- The lens is dirty or covered with condensation.
- Clean the lens and check the focus again. (⇨ pg. 57)

The colour of the image looks strange.

- The light source or the subject does not include white. Or there are various different light sources behind the subject.
- Try manual white balance adjustment. (⇨ pg. 34)

The recorded image is too dark.

- Shooting was performed under backlit conditions.
- Try backlight compensation (⇨ pg. 31) or manual exposure. (⇨ pg. 32)

The recorded image is too bright.

- The subject is too bright.
- Try manual exposure. (⇨ pg. 32)

White balance setting cannot be activated.

- The sepia (SEPIA) or monotone (MONOTONE) mode is activated.
- Turn off the sepia (SEPIA) or monotone (MONOTONE) mode before setting white balance. (⇨ pg. 36)

The black & white fader does not work.

- The sepia (SEPIA) or monotone (MONOTONE) mode is activated.
- Turn off the sepia (SEPIA) or monotone (MONOTONE) mode. (⇨ pg. 37)

The continuous shooting speed of still images is slow.

- The continuous shooting speed will drop when repeatedly making continuous shots, when using certain recording medium, or under certain recording conditions. (⇨ pg. 28)

Other problems

The power/charge lamp on the camera does not light during charging.

- Charging is difficult in places subject to extremely high/low temperatures.
- To protect the battery, it is recommended to charge it in places with a temperature of 10°C to 35°C. (⇨ pg. 58)

The data process is too slow after the power is switched on or the mode is changed.

- There is a large number of still images (approx. 1,000 or more) stored in the recording medium.
- Copy the stored files to a PC, and delete them from the recording medium.

[SET DATE/TIME!] appears.

- The built-in clock's rechargeable lithium battery is discharged.
- The previously set date/time is erased.
- Connect the camera to an AC outlet using the AC adapter for over 24 hours to charge the clock's lithium battery. Then set the date/time. (⇨ pg. 18)

Files cannot be deleted.

- Files are protected.
- Remove protection from the files and delete them. (⇨ pg. 38, 50)

When the image is printed from the printer, a black bar appears at the bottom of the screen.

- This is not a malfunction.
- By recording with DIS activated, this can be avoided. (⇨ pg. 50)

Images on the LCD monitor appear dark or whitish.

- In places subject to low temperature, images become dark due to the characteristics of the LCD monitor. This is not a malfunction.
- Adjust the brightness and angle of the LCD monitor. (⇨ pg. 9, 18, 49)
- When the LCD monitor's fluorescent light reaches the end of its service life, images on the LCD monitor become dark.
- Consult your nearest JVC dealer.

Coloured bright spots appear all over the LCD monitor.

- The LCD monitor is made with high precision technology. However, black spots or bright spots of light (red, green or blue) may appear constantly on the LCD monitor. These spots are not recorded on the picture. This is not due to any defect of the unit. (Effective dots: more than 99.99 %)

The SD card cannot be removed from the camera.

- Push in the SD card a few more times. (⇨ pg. 19)

Picture does not appear on the LCD monitor.

- The LCD monitor's brightness setting is too dark.
- Adjust the brightness of the LCD monitor. (⇨ pg. 18, 49)

Warning Indications

The following indications appear on the screen.

(Battery indicator)

Displays the battery remaining power.

Remaining power level

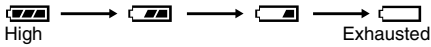

- As the battery power comes close to nil, the battery indicator blinks. When the battery power is exhausted, power turns off automatically.

SET DATE/TIME!

- Appears when the date/time is not set. (⇨ pg. 18)
- Appears when the built-in clock (lithium) battery is discharged and the previously set date/time is erased. (⇨ pg. 18)

LENS CAP

Appears for 5 seconds after power is turned on with the power switch set to , if the lens cap is attached or when it is dark.

PLEASE INSERT MEMORY CARD!

Appears when no SD card is inserted in the SD slot. (⇨ pg. 19)

HARD DISK DRIVE IS NOT FORMATTED

Appears when the built-in hard disk needs to be formatted.

THIS CARD IS NOT FORMATTED

Appears when an unformatted SD card is inserted.

HARD DISK DRIVE IS FULL

Appears when the built-in hard disk is full and recording is not possible.

MEMORY IS FULL

Appears when the SD card is full and recording is not possible.

HDD ERROR!

MEMORY CARD ERROR!

Appears when some errors occurred with the recording media.

- Remove the card once and insert it again. If the error is not cancelled, replace the card with one that has been guaranteed for correct operation. (⇨ pg. 19, 62)
- Perform clean up to restore the capacity of the recording media. (⇨ pg. 40)
- It is recommended to run check disk regularly on the PC, on condition that there is no data on the hard disk of the camera.

CHECK CARD'S WRITE PROTECTION SWITCH

Appears when you attempt recording when the write protection tab on the SD card is set to the "LOCK" position. (⇨ pg. 19)

NO VIDEO FILES STORED!

Appears if there are no video files when you attempt video playback.

NO IMAGE FILES STORED!

Appears if there are no still image files when you attempt still image playback.

CLOSE COVER

Appears when the SD card cover is opened during file copy/move operation. (⇨ pg. 41)

NO MEMORY CARD

Appears when the SD card is not inserted to the SD slot for file copy/move operation. (⇨ pg. 41)

NO SUPPORTED FILES

Appears when there is no JPEG (still image) files to be copied or moved in recording media. (⇨ pg. 41)

NUMBER OF FOLDERS OVERFLOW

Appears when the number of folders exceeds the limit for file copy/move operation.

MEMORY CARD ERROR! REINSERT CARD OR CHANGE CARD.

Appears when the camera does not recognise the loaded SD card. Remove the card once and insert it again or replace with another card. (⇨ pg. 19)

FILE SYSTEM MAY HAVE PROBLEM. FORMAT IS RECOMMENDED AFTER COPYING WANTED DATA.

The file system of the recording medium may have a problem. It is recommended to copy the data for backup, then format the medium. (⇨ pg. 20)

VIDEO MANAGEMENT FILE IS BROKEN. TO RECORD/PLAYBACK VIDEO, RECOVERY IS REQUIRED. RECOVER?

The video management file is broken. Recovery is required to record or play back video files. Press \wedge/\vee to select [YES], then press $\blacktriangleright\parallel$ to recover the video management file. If the desired video file is not displayed on the video index screen in spite of the file recovery, the file is moved to the [EXTMOV] folder. Press the recording start/stop button on the index screen to display [MPG], and then select the desired file.

**NO VIDEO MANAGEMENT FILE
VIDEO FILES HAVE BEEN MOVED TO MPEG
FOLDER**

The data cannot be recorded properly, or the video management file is deleted or not found. Video files have been moved to MPEG (EXTMOV) folder. (⇨ pg. 22)

**PLAY LIST'S MANAGEMENT INFORMATION
IS BROKEN. REMAKE PLAY LIST AGAIN.**

The management information of play list is broken. Create the play list again. (⇨ pg. 42)

**NO REGISTERED SCENES IN PLAY LIST.
SOME OF SCENES MAY NOT BE PLAYED
BACK.**

The video files registered in the play list do not exist. Some of the scenes may not be played back.

**REGISTERED SCENES IN PLAY LIST IS
EMPTY. THIS PLAY LIST WILL BE DELETED.**

There is no scenes registered in the play list. The play list will be deleted.

**CAMERA TEMPERATURE IS GOING UP.
TURN CAMERA OFF, PLEASE WAIT.**

The temperature of the camera is too high. Turn off the power, then wait for a while.

**CAMERA TEMPERATURE IS TOO LOW.
KEEP CAMERA POWER ON, PLEASE WAIT.**

The temperature of the camera is too low. Keep the power on and wait for a while.

RECORDING FAILURE

- Performance of recording medium is poor. Use the Cleanup function [CLEAN UP] in the menu. (⇨ pg. 40, 49)
- The writing speed of recording medium is slow, or the recording medium is corrupted. Use the recording medium to which the operation is guaranteed. See page 62 for the guaranteed media to work with this camera.
- The recording medium was subjected to vibrations or jolts. Be careful not to subject the recording medium to vibrations or jolts.

**RECORDING MAY NOT BE CORRECT ON
THE MEMORY CARD**

The data may not be recorded on the recording medium correctly. Try recording again. Otherwise, clean up the recording medium. (⇨ pg. 40, 49)

**MEMORY CARD CANNOT BE PLAYED BACK
CORRECTLY**

The recording medium cannot be played back correctly. Try playback again.

CANNOT USE IN VIDEO MODE

The operation is not available in the video mode.

**DROP DETECTION WORKED AND THE
POWER IS TURNED OFF**

The drop detection function operated, and the power was turned off. The file that was being recorded may have been saved into the [EXTMOV] folder. (⇨ pg. 22)

Cleaning the Camera

Before cleaning, turn off the camera and remove the battery pack and AC adapter.

To clean the exterior

Wipe gently with a soft cloth. Put the cloth in diluted mild soap and wring it well to wipe off heavy dirt. Then wipe again with a dry cloth.

To clean the LCD monitor

Wipe gently with a soft cloth. Be careful not to damage the monitor.

To clean the lens

Wipe gently with lens cleaning paper.

NOTES:

- Avoid using strong cleaning agents such as benzine or alcohol.
- Cleaning should be done only after the battery pack has been removed or other power units have been disconnected.
- Mould may form if the lens is left dirty.
- When using a cleaner or chemically treated cloth refer to the cautions of each product.

Cautions

Battery Packs

The supplied battery pack is a lithium-ion battery. Before using the supplied battery pack or an optional battery pack, be sure to read the following cautions:

- **To avoid hazards**
 - ... **do not** burn.
 - ... **do not** short-circuit the terminals. When transporting, make sure the provided battery cap is attached to the battery. If the battery cap is misplaced, carry the battery in a plastic bag.
 - ... **do not** modify or disassemble.
 - ... **do not** expose the battery to temperatures exceeding 60°C, as this may cause the battery to overheat, explode or catch fire.
 - ... use only specified chargers.

Terminals

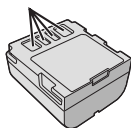

- **To prevent damage and prolong service life**
 - ...do not subject to unnecessary shock.
 - ...charge in an environment where temperatures are within the tolerances shown in the chart below.
This is a chemical reaction type battery — cooler temperatures impede chemical reaction, while warmer temperatures can prevent complete charging.
 - ...store in a cool, dry place. Extended exposure to high temperatures will increase natural discharge and shorten service life.
 - ...fully charge and then fully discharge the battery every 6 months when storing the battery pack over a long period time.
 - ...remove from charger or powered unit when not in use, as some machines use current even when switched off.

NOTES:

- It is recommended that only genuine JVC batteries are used in this camera. Using generic non-JVC batteries can cause damage to the internal charging circuitry.
- It is normal for the battery pack to be warm after charging, or after use.
Temperature range specifications
Charging: 10°C to 35°C
Operation: 0°C to 40°C
Storage: -20°C to 50°C
- The lower the temperature, the longer the recharging takes.

Recording Medium

- **Be sure to follow the guidelines below to prevent corruption or damage to your recorded data.**
 - Do not bend or drop the recording medium, or subject it to strong pressure, jolts or vibrations.
 - Do not splash the recording medium with water.
 - Do not use, replace, or store the recording medium in locations that are exposed to strong static electricity or electrical noise.
 - Do not turn off the camera power or remove the battery or AC adapter during shooting, playback, or when otherwise accessing the recording medium.
 - Do not bring the recording medium near objects that have a strong magnetic field or that emit strong electromagnetic waves.
 - Do not store the recording medium in locations with high temperature or high humidity.
 - Do not touch the metal parts.
- **Copy the recorded files to your PC. JVC shall not be responsible for any lost data. (It is recommended that you copy the data from your PC to DVD or other media for storage.)**
- **A malfunction may cause the recording medium to fail to operate properly. JVC shall not provide any compensation for any lost contents.**

LCD Monitor

- **To prevent damage to the LCD monitor, DO NOT**
 - ...push it strongly or apply any shocks.
 - ...place the camera with LCD monitor on the bottom.
- **To prolong service life**
 - ...avoid rubbing it with coarse cloth.
- **Be aware of the following phenomena for LCD monitor use. These are not malfunctions.**
 - ...While using the camera, the surface around the LCD monitor may heat up.
 - ...If you leave power on for a long time, the surface around the LCD monitor becomes hot.

Main Unit

- **For safety, DO NOT**
 - ... open the camera's chassis.
 - ... disassemble or modify the unit.
 - ... short-circuit the terminals of the battery pack. Keep it away from metallic objects when not in use.
 - ... allow inflammables, water or metallic objects to enter the unit.
 - ... remove the battery pack or disconnect the power supply while the power is on.
 - ... leave the battery pack attached when the camera is not in use.
- **Avoid using the unit**
 - ... in places subject to excessive humidity or dust.
 - ... in places subject to soot or steam such as near a cooking stove.
 - ... in places subject to excessive shock or vibration.
 - ... near a television set.
 - ... near appliances generating strong magnetic or electric fields (speakers, broadcasting antennas, etc.).
 - ... in places subject to extremely high (over 40°C) or extremely low (under 0°C) temperatures.
- **DO NOT leave the unit**
 - ... in places of over 50°C.
 - ... in places where humidity is extremely low (below 35%) or extremely high (above 80%).
 - ... in direct sunlight.
 - ... in a closed car in summer.
 - ... near a heater.
- **To protect the unit, DO NOT**
 - ... allow it to become wet.
 - ... drop the unit or strike it against hard objects.
 - ... subject it to shock or excessive vibration during transportation.
 - ... keep the lens directed at extremely bright objects for long periods.
 - ... expose the lens to direct sunlight.
 - ... swing it excessively when using the hand strap.
 - ... swing the soft camera case excessively when the camera is inside it.

How to Handle a CD-ROM

- Take care not to soil or scratch the mirror surface (opposite to the printed surface). Do not write anything or put a sticker on either the front or back surface. If the CD-ROM gets dirty, gently wipe it with a soft cloth outward from the centre hole.
- Do not use conventional disc cleaners or cleaning spray.
- Do not bend the CD-ROM or touch its mirror surface.
- Do not store your CD-ROM in a dusty, hot or humid environment. Keep it away from direct sunlight.

Serious malfunctioning

If malfunctioning occurs, stop using the unit immediately and consult your local JVC dealer.

When requesting repairs for malfunctioning by your dealer or JVC service centre, be sure to bring your camera together with the recording medium. If one of them is not included, the cause cannot be diagnosed, and the repair cannot be made properly.

The camera is a microcomputer-controlled device. External noise and interference (from a TV, a radio, etc.) might prevent it from functioning properly. In such cases, first disconnect its power supply unit (battery pack, AC adapter, etc.) and wait a few minutes and then re-connect it and proceed as usual from the beginning.

Specifications

Camera

For general

Power supply

DC 11 V (Using AC adapter)

DC 7.2 V (Using battery pack)

Power consumption

Approx. 5.2 W

Dimensions (W x H x D)

71 mm x 70 mm x 109 mm

Weight

Approx. 390 g

(without battery, lens cap and strap)

Approx. 450 g

(incl. battery, lens cap and strap)

Operating temperature

0°C to 40°C

Operating humidity

35% to 80%

Storage temperature

-20°C to 50°C

Pickup

1/3.6" (2,120,000 pixels) CCD

Lens

F 1.8 to 2.2, f = 4.5 mm to 45 mm, 10:1 power zoom lens

Filter diameter

ø30.5 mm

LCD monitor

2.5" diagonally measured, LCD panel/TFT active matrix system

Speaker

Monaural

Flash

Within 2 m

(recommended shooting distance)

For video/audio

Format

SD-VIDEO

Recording/Playback format

Video: MPEG-2

Audio: Dolby Digital (2 ch)

Signal format

PAL standard

Recording mode (video)

ULTRA FINE: 720 x 576 pixels, 8.5 Mbps (CBR)

FINE: 720 x 576 pixels, 5.5 Mbps (CBR)

NORMAL: 720 x 576 pixels, 4.2 Mbps (VBR)

ECONOMY: 352 x 288 pixels, 1.5 Mbps (VBR)

Recording mode (audio)

ULTRA FINE: 48 kHz, 384 kbps

FINE: 48 kHz, 384 kbps

NORMAL: 48 kHz, 256 kbps

ECONOMY: 48 kHz, 128 kbps

For still image**Format**

JPEG

Image size

4 modes (1600 x 1200 / 1280 x 960 / 1024 x 768 / 640 x 480)

Picture quality

2 modes (FINE/STANDARD)

For connectors**AV**

S-Video output:

Y: 1.0 V (p-p), 75 Ω , analogueC: 0.29 V (p-p), 75 Ω , analogueVideo output: 1.0 V (p-p), 75 Ω , analogueAudio output: 300 mV (rms), 1 k Ω , analogue, stereo**USB**

Mini USB-B type, USB 1.1/2.0 compliant

AC Adapter**Power requirement**AC 110 V to 240 V \sim , 50 Hz/60 Hz**Output**DC 11 V --- , 1 A**Remote Control****Power supply**

DC 3 V

Battery life

Approx. 1 year (depending on the frequency in use)

Operating distance

Within 5 m

Operating temperature

0°C to 40°C

Dimensions (W x H x D)

45 mm x 11 mm x 105 mm

WeightApprox. 40 g
(incl. battery)

Design and specifications subject to change without notice.

Recording Time and Number of Images

The tables below show the approximate recording time and number of storable images. The number increases or decreases depending on the conditions such as image size and/or picture quality. The first column in the table indicates the conditions.

Compatible recording media

The following SD cards have been guaranteed to work with this camera. Others are not guaranteed to work, so buy such products with caution.

SD Memory Cards: By Panasonic, TOSHIBA, pqi (still image only) and SanDisk

- If other media are used, they may fail to record data correctly, or they may lose data that has already been recorded.
- MultiMediaCards are not supported.
- For video recording, use a high-speed SD Memory Card (at least 10 MB/s).

 : Approximate recording time (for video)

(The numbers indicate "minutes".)

- Built-in hard disk

Quality	Recording Time
ULTRA FINE	430
FINE	640
NORMAL	850
ECONOMY	2250

- SD card

Quality	128 MB	256 MB	512 MB	1 GB
ULTRA FINE	1	3	7	14
FINE	2	5	10	21
NORMAL	3	6	14	27
ECONOMY	8	18	37	73

 : Approximate number of storable images (for still image)

- Built-in hard disk

Image size/ quality	Number of images
640 x 480/ FINE	9999
640 x 480/ STANDARD	9999
1024 x 768/ FINE	9999
1024 x 768/ STANDARD	9999
1280 x 960/ FINE	9999
1280 x 960/ STANDARD	9999
1600 x 1200/ FINE	9999
1600 x 1200/ STANDARD	9999

- SD card

Image size/ quality	128 MB	256 MB	512 MB	1 GB
640 x 480/ FINE	770	1555	3140	6040
640 x 480/ STANDARD	1105	2225	4490	8635
1024 x 768/ FINE	320	645	1305	2515
1024 x 768/ STANDARD	550	1110	2240	4315
1280 x 960/ FINE	220	440	895	1725
1280 x 960/ STANDARD	350	705	1425	2745
1600 x 1200/ FINE	135	280	570	1095
1600 x 1200/ STANDARD	230	470	950	1830

A		M	
AC Adapter	16	Manual Exposure	32, 33
B		Manual Focus	33
Backlight Compensation	31	MSET Menu	32
Battery Pack	14	O	
Brightness Control	18, 49	Operation Sound	48
C		P	
Changing The Menu Settings	48 – 51	Picture Quality	50, 51
Charging The Battery Pack	14	Play List	42 – 45, 50
Cleaning Up a Recording Medium	40, 49	Power-Linked Operation	17
Connection to a TV, VCR or DVD Recorder	26	Program AE	36
Continuous Shooting	28	Protecting Files	38, 50
Copying/Moving Still Image Files	41, 49	R	
D		Remote Control	27
Data Battery	16	Resetting The File Number	42, 49
Date Index Screen	25, 30	S	
Date/Time Settings	18	Scroll Bar	25, 30
Deleting Files	39	SD Memory Card	19
Demonstration Mode	48	Self-Timer	51
Digital Image Stabiliser (DIS)	50	Shutter Speed	35
Direct Printing	47	Slide Show	29
DPOF Print Setting (Digital Print Order Format)	46	Slow Motion Playback	25
Drop Detection	49	Speaker Volume	24
Dubbing	26, 45	Spot Exposure Control	31
E		T	
Effect	36, 37	Tele Macro	50, 51
F		Tripod Mounting	19
File Information	38	Troubleshooting	52
Flash	31	W	
Formatting a Recording Medium	20, 49	Warning Indications	55
G		White Balance	34
Gain	51	Wide Mode	50
Gain Up	50	Wind Cut	50
I		Wipe or Fader Effects	37
Image Rotation	30	Z	
Image Size	51	Zooming	23, 25, 28, 30, 50
Index Screen	24, 29		
L			
Language Setting	17, 49		
LCD Monitor	9, 12, 58		

JVC



JVC



ENGLISH

**SOFTWARE INSTALLATION AND
USB CONNECTION GUIDE**

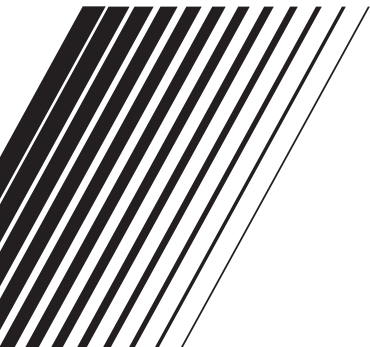

LYT1473-001A

EN

JVC SOFTWARE LICENSE AGREEMENT	2
Notice for Users	6
System Requirements	8
Software Installation (Windows®)	11
Connections (Windows®)	13
Viewing the Contents of a Recording Medium (Windows®)	14
Copying Files to the PC (Windows®)	16
Playing Back Files on the PC (Windows®)	17
Disconnecting the USB cable (Windows®)	17
User's Guide/Help/Readme (Windows®)	18
Backing Up Video files (Windows®)	19
Playing Back Copied Video (Windows®)	20
How To Create DVDs simply (Windows®)	21
Creating a DVD with Titles (Windows®)	23
Software Installation (Macintosh)	26
Connections (Macintosh)	28
Viewing the Contents of a Recording Medium (Macintosh)	28
Copying Files to the PC (Macintosh)	30
Disconnecting the USB cable (Macintosh)	30
Help/Readme (Macintosh)	31
File Combination (Macintosh)	31
File Trimming (Macintosh)	33

IMPORTANT

TO CUSTOMERS: PLEASE MAKE SURE TO READ THIS CAREFULLY BEFORE INSTALLING OR USING THE SOFTWARE PROGRAM NAMED "DIGITAL PHOTO NAVIGATOR" ("Program") ON YOUR PC.

The right to use the Program is granted by Victor Company of Japan, Limited ("JVC") to You only on the condition that You agree to the following.

Should You not agree to the terms hereof, You may not install or use the Program. HOWEVER, INSTALLING OR USING THE PROGRAM INDICATES YOUR ACCEPTANCE OF THESE TERMS AND CONDITIONS.

1 COPYRIGHT; OWNERSHIP

You acknowledge that all copyrights and other intellectual property rights in the Program are owned by JVC and its licensor, and remain vested in JVC and such licensor. The Program is protected under the copyright law of Japan and other countries, and related Conventions.

2 GRANT OF LICENSE

- (1) Subject to the conditions of this Agreement, JVC grants to You a non-exclusive right to use the Program. You may install and use the Program on a HDD or other storage devices incorporated in Your PC.
- (2) You may make one (1) copy of the Program solely for your personal backup or archival purposes.

3 RESTRICTION ON THE PROGRAM

- (1) You may not reverse engineer, decompile, disassemble, revise or modify the Program, except to the extent that expressly permitted by applicable law.
- (2) You may not copy or use the Program, in whole or in part, other than as expressly specified in this Agreement.
- (3) You have no right to grant a license to use the Program, and may not distribute, rent, lease or transfer the Program to any third party or otherwise let them use the Program.

4 LIMITED WARRANTY

JVC warrants that any media in which the Program is embodied are free from any defects in materials and workmanship for a period of thirty (30) days from the date of Your purchasing any our products accompanying the Program. JVC's entire liability and your exclusive remedy in connection with the Program shall be replacement of such defective media. EXCEPT FOR THE EXPRESS WARRANTIES STATED HEREIN AND TO THE EXTENT PERMITTED BY APPLICABLE LAW, JVC AND ITS LICENSORS DISCLAIM ANY OTHER WARRANTIES, EITHER EXPRESS OR IMPLIED, INCLUDING BUT NOT LIMITED TO IMPLIED WARRANTIES OF MERCHANTABILITY AND FITNESS FOR A PARTICULAR PURPOSE IN REGARD TO THE PROGRAM AND THE ACCOMPANYING PRINTED MATERIALS. SHOULD THERE BE ANY PROBLEM ARISING FROM OR CAUSED BY THE PROGRAM, YOU SHOULD SETTLE ALL SUCH PROBLEM AT YOUR OWN COST AND EXPENSE.

5 LIMITED LIABILITY

TO THE EXTENT PERMITTED BY APPLICABLE LAW, IN NO EVENT SHALL JVC AND ITS LICENSORS BE LIABLE FOR ANY INDIRECT, SPECIAL, INCIDENTAL OR CONSEQUENTIAL DAMAGES WHATSOEVER, REGARDLESS OF THE FORM OF ACTION WHETHER IN CONTRACT, TORT OR OTHERWISE ARISING OUT OF OR IN CONNECTION WITH THE USE OF OR INABILITY TO USE THE PROGRAM, EVEN IF JVC HAS BEEN ADVISED OF THE POSSIBILITY OF SUCH DAMAGES. YOU WILL INDEMNIFY AND HOLD HARMLESS JVC FROM ANY LOSS, LIABILITY OR COST ARISING OUT OF OR IN ANY WAY CONNECTED TO CLAIMS FROM ANY THIRD PARTY RELATING TO THE USE OF THE PROGRAM.

6 TERM

This Agreement will become effective on the date when You install and use the Program on Your machine, and continue to be in effect until the termination under the following provision.

Should You breach any provision of this Agreement, JVC may terminate this Agreement without giving any notice to You. In this event, JVC may claim against You for any damages caused by Your breach. Should this Agreement be terminated, You must immediately destroy the Program stored in Your machine (including the erasing from any memory in Your PC), and no longer own such Program.

7 EXPORT CONTROL

You agree that You will not ship, transfer or export the Program or underlying information and technology to any countries to which Japan and other relevant countries have initiated an embargo on such goods.

8 U.S. GOVERNMENT USER

If You are an agency of the United States of America (the "Government"), You acknowledge JVC's representation that the Program is a "Commercial Item" as defined in Federal Acquisition Regulation (FAR) part 2.101 (g) consisting unpublished "Commercial Computer Software" as those items are used at FAR part 12.212 and is only licensed to You with the same use rights JVC grants all commercial end users pursuant to the terms of this Agreement.

9 GENERAL

- (1) No modification, change, addition, deletion or other alternation of or to this Agreement will be valid unless reduced to writing and signed by an authorized representative of JVC.
- (2) If any part of this Agreement is held invalid by or in conflict with any law having jurisdiction over this Agreement, the remaining provisions will remain in full force and effect.
- (3) This Agreement shall be governed by and interpreted under the laws of Japan. The Tokyo District Court has jurisdiction over all disputes which may arise with respect to the execution, interpretation and performance of this Agreement.
Victor Company of Japan, Limited

NOTE:

If You acquired the Program in Germany, the provisions of Sections 4 (Limited Warranty) and 5 (Limited Liability) provided above will be replaced with those of the German version of this Agreement.

CAUTION:

- Operate this equipment according to the operating procedures described in this manual.
- Use only the provided CD-ROM. Never use any other CD-ROM to run this software.
- Do not attempt to modify this software.
- Changes or modifications not approved by JVC could void user's authority to operate the equipment.

How to handle a CD-ROM

- Take care not to soil or scratch the mirror surface (opposite to the printed surface). Do not write anything or put a sticker on either the front or back surface. If the CD-ROM gets dirty, gently wipe it with a soft cloth outward from the center hole.
- Do not use conventional disc cleaners or cleaning spray.
- Do not bend the CD-ROM or touch its mirror surface.
- Do not store your CD-ROM in a dusty, hot or humid environment. Keep it away from direct sunlight.

You can find the latest information (in English) on the provided software program at our world wide web server at <http://www.jvc-victor.co.jp/english/global-e.html>

Notice for Users

Use of this software is authorized according to the terms of the software license.

JVC

When contacting the nearest JVC office or agency in your country about this software (refer to the JVC Worldwide Service Network at <http://www.jvc-victor.co.jp/english/worldmap/index-e.html>), please fill out the following and have the appropriate information ready.

Product Name		
Model		
Problem		
Error Message		
PC	Manufacturer	
	Model	<input type="checkbox"/> Desktop <input type="checkbox"/> Laptop
	CPU	
	OS	
	Memory	MB
	Available Hard Disk Space	MB

Please note that it may take some time to respond to your questions, depending on their subject matter.

JVC cannot answer questions regarding basic operation of your PC, or questions regarding specifications or performance of the OS, other applications or drivers.

CyberLink

For details of CyberLink's technical support service, refer to the "Readme" of each software or the following list. To access "Readme", refer to "User's Guide/Help/Readme (Windows®)" (pg. 18).

Region	Location	Phone #	Web	Language
		Fax #		
Europe 1	Germany (aixTeMa)	+49-700-462-92375	support.gocyberlink.com	German / French / English
		+49-241-70525-25		
Europe 2	Europe area other than Germany	—————	support.gocyberlink.com	English
US/Canada	US	+1-510-668-0118	support.gocyberlink.com	English
		—————		
Asia & Pacific 1	South Korea	+82-31-716-8386	www.gocyberlink.co.kr	Korean
		+82-31-718-5173		
Asia & Pacific 2	Taiwan	+886-2-8667-1298	support.cyberlink.com.tw	Mandarin / English
		+886-2-8667-1300	support.gocyberlink.com	
Asia & Pacific 3	Australia & New Zealand (Manacom)	+61-7-3870-4900	support.gocyberlink.com	English
		+61-7-3870-9440		

PIXELA

For technical inquiries, please contact the PIXELA User Support Center in your region.

Region	Location	Phone #
North America	Los Angeles	+1-213-341-0163
Europe	U.K.	+44-1489-564-764
Asia	Philippines	+63-2-438-0090

Please check the PIXELA website for latest information and downloading.

<http://www.pixela.co.jp/oem/jvc/e/index.html>

System Requirements

Windows®

■ Digital Photo Navigator

The following requirements must be satisfied to connect a camera to a PC and to use Digital Photo Navigator.

OS	: Windows® 2000 Professional SP4 [2000] (pre-installed), Windows® XP Home Edition [XP] (pre-installed), or Windows® XP Professional [XP] (pre-installed)
CPU	: Intel® Pentium® III, at least 700 MHz
RAM	: At least 128 MB
Free hard disk space	: At least 10 MB for installation, at least 500 MB recommended
Connector	: USB 2.0 connector
Display	: Must be capable of displaying 800 x 600 dots with 16-bit color
Miscellaneous	: Internet Explorer 5.5 or later

■ CyberLink DVD Solution

The following requirements must be satisfied to use CyberLink DVD Solution.

OS	: Windows® 2000 Professional SP4 [2000] (pre-installed), Windows® XP Home Edition [XP] (pre-installed), or Windows® XP Professional [XP] (pre-installed)
CPU	: Intel® Pentium® III, at least 700 MHz (Intel® Pentium® 4, at least 2 GHz recommended)
RAM	: At least 128 MB (at least 256 MB recommended)
Free hard disk space	: At least 350 MB for installation For creating DVD Video, at least 10 GB recommended For creating VCD, at least 1 GB recommended
Connector	: USB 2.0 connector
Display	: Must be capable of displaying 1024 x 600 dots
Miscellaneous	: Internet Explorer 5.5 or later DirectX 9.0 or later DirectX is necessary so that CyberLink DVD Solution works properly and it is automatically installed during CyberLink DVD Solution installation.
Supported media	: DVD-Video: DVD-R/-RW, DVD+R/+RW DVD-VR: DVD-RW, DVD-RAM DVD+VR: DVD+RW VideoCD: CD-R/RW For the compatible DVD/CD burners, refer to CyberLink web site: http://www.gocyberlink.com/english/products/powerproducer/2_gold/comp_dvd_drives.jsp

Macintosh

■ Capty MPEG Edit EX

The following requirements must be satisfied to use Capty MPEG Edit EX.

Hardware	: iMac G4, iMac G5, iBook G4, Power Mac G5, PowerBook G4, eMac, Mac Mini
OS	: Mac OS X (v10.2.8, v10.3.1 to v10.3.9)
CPU	: At least PowerPC G4/800 MHz or more
RAM	: At least 128 MB (at least 256 MB recommended)
Free hard disk space	: At least 30 MB for installation
Connector	: Must be standard equipped with USB 2.0 connector
Display	: Must be capable of displaying 1024 x 768 dots with full color
Miscellaneous	: QuickTime 6.5 or later

-
- The system requirements information above is not a guarantee that the provided software will work on all personal computers meeting those requirements.
 - Windows[®] is either registered trademark or trademark of Microsoft Corporation in the United States and/or other countries.
 - Macintosh is a registered trademark of Apple Computer, Inc.
 - Other product and company names included in this instruction manual are trademarks and/or registered trademarks of their respective holders.
 - If your PC does not meet the system requirements above, you can use the optional USB reader/writer CU-VUSD70, the PC card adapter CU-VPD60 or the floppy disk adapter CU-VFSD50 to load the files in the memory card to the hard disk on your PC.
(Refer to “JVC Accessories” on our world web site at: <http://www.jvc-victor.co.jp/english/accessory/>)

Software Installation (Windows®)

Follow the procedure described below to install the software. From the [SETUP] screen in step **2**, you can install the following drivers or software. Before start installing, quit any other software you are using. (Check that there are no other application icons on the status bar.)

Digital Photo Navigator 1.5

This application is used to organize still images and convert them into a variety of formats.

CyberLink DVD Solution

PowerProducer 2 Gold NE

PowerProducer 2 Gold NE is software for creating movie discs incorporating not only video but also slideshows. This software uses a simple wizard format for creating a wide range of different format discs. You can also edit imported video. You can import video from the camera, edit it, and then create a slideshow from still images. You can create a customized menu for the video or slideshow and write the contents to DVD or other media.

PowerDirector Express NE

PowerDirector Express NE is software for easily editing MPEG, AVI, and other video files, still images, and other contents for creating a movie. This software has an interface that allows editing in either timeline or storyboard mode, maintains superior image quality, uses SVRT for high-speed rendering, and has a host of other advanced video editing features.

PowerDVD 5 NE

PowerDVD 5 NE is software for playing back DVD-Video and video files.

1 Load the provided CD-ROM into the PC. After a moment, the [SETUP] screen appears.

- From the [SETUP] screen, you can install the desired software.
- If the [SETUP] screen does not appear, double-click the CD-ROM icon in the [My Computer] window.

2 Click [Install] on the right side of the desired software and follow the on screen instructions to complete the installation.

The installation of the selected software starts. The procedure differs depending on the software.



Following steps are the example of CyberLink DVD Solution.

3 Click [Install] on the right side of [CyberLink DVD Solution] on the [SETUP] screen.

[Choose Setup Language] screen appears.

4 Select the desired language and click [OK].



The [CyberLink DVD Solution Setup] screen in step **5** appears.

- If [Information] screen for Windows Messenger appears, refer to page 13.

5 Click [Next].

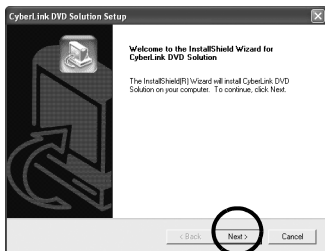

[License Agreement] screen appears.

6 Click [Yes].

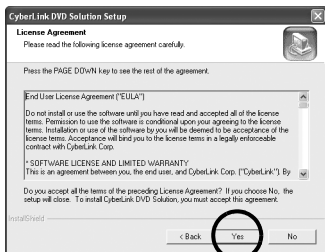

[Customer Information] screen appears.

7 Confirm your information and click [Next].

- It is possible to change the information.

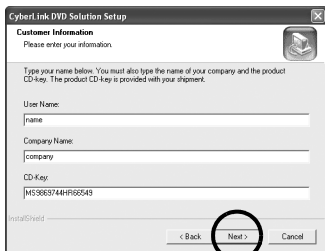

[Choose Destination Location] screen appears.

8 Click [Next].

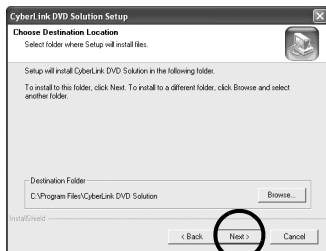

[Setup Type] screen appears.

9 Select the program(s) you want to install, then click [Next].

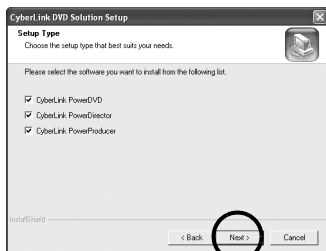

[Setup Status] screen appears. Wait for a moment until the installation is finished and [Setup Complete] screen appears.

10 Click [Finish] then restart the PC.

Install all of the desired software in the same way.

To display [SETUP] screen, double-click the CD-ROM icon in the [My Computer] window.

NOTES:

- If PowerDirector/PowerProducer/PowerDVD have already been installed on the PC, uninstall them before installing the provided software. Video files captured with this camera can only be handled on the provided software. Please install and use the provided software (PowerDirector Express NE, PowerProducer 2 Gold NE, PowerDVD 5 NE).
- If you perform installation of a software that is already installed, uninstallation will start. In this case, perform the installation again after uninstallation is finished.
- Windows Messenger has to be closed during CyberLink DVD Solution installation. If it is running during installation, [Information] screen appears.



To close Windows Messenger:

- 1) While holding [Ctrl + Alt] key, click [Delete] key so that [Task Manager] appears.
- 2) Click [Processes] tab.
- 3) Select [mmsgs.exe].
- 4) Click [End process].

Connections (Windows®)

Connecting the USB cable

Connect the USB cable to copy still images and video files in a recording medium to the PC.

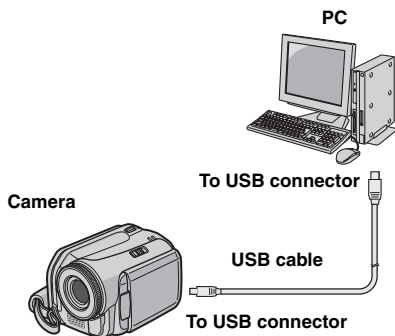

1 To assure safety, make sure all units are turned off before making any connections.

2 Use the USB cable to connect the camera to the PC.

NOTES:

- It is recommended to use the AC Adapter as the power supply instead of the battery pack.
- When the USB cable is connected, turning on or off the camera causes malfunctions of the PC.
- Connect the camera directly to the PC, not through the hub.
- Do not use an extension USB cable.

Viewing the Contents of a Recording Medium (Windows®)

1 If you want to view the contents in the SD Memory Card, make sure that the card is set in the camera.

2 Set the camera's power switch to the playback mode while pressing down the lock button located on the switch. The camera turns on.

3 Connect the camera to the PC with a USB cable. (☞ pg. 13)

On the camera's LCD monitor [USB MASSSTORAGE] appears.

4 When using Windows® XP:

The [Removable Disk] window appears on the PC's screen after a moment.

Select [Open folders to view files using Windows Explorer] and click [OK].

NOTE:

If the [Removable Disk] window does not appear, confirm the connection (☞ pg. 13) or perform the steps ① and ②.

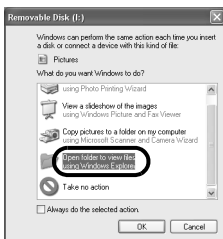

When using Windows® 2000:

① Double-click the [My Computer] icon on the desktop.

The [Removable Disk] icon which represents the recording



medium in the

camera appears in the [My Computer] window. If the SD card is in the camera, two [Removable Disk] icons appear. Check the contents in each recording medium.

② Double-click the [Removable Disk] icon.

5 The folders in the recording medium appear.

Different file types are stored in different folders.

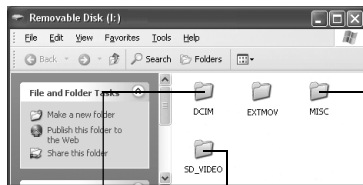

Still images

Video files

DPOF setting data

Folder structure within the recording medium

Video files: Stored in the [PRGxxx] folder (where xxx is a number), within the [SD_VIDEO] folder.

Still image files: Stored in the [xxxJVCSO] folder (where xxx is a number), within the [DCIM] folder.

Recording medium

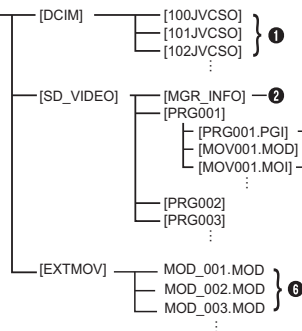

[DCIM]: Contains folders with still images (JPEG) (extension “.jpg”)

[SD_VIDEO]: Contains folders with video (MPEG2) files (extension “.mod”)

[EXTMOV]: Contains video (MPEG2) files which are not recorded or saved properly (extension “.mod”)

[MISC]: Contains folders with DPOF setting data

① Still image file folder

② Management information for the media as a whole

③ Management information

④ Video file

⑤ Management information for the video file

⑥ Video file that failed to be produced by an accident such as when dropped

* Management information: Information such as the date and time of recording, recorded with the video file.

NOTES:

- Any folders or files other than those described above are also recorded in the recording medium.
- Saving the wrong kinds of files in a recording medium or deleting files or folders from a recording medium can cause problems with the operation of the camera. When it is necessary to delete a file from a recording medium, delete it through the camera. Also, do not move or rename folders and files within the medium on PC.
- Never disconnect the USB cable while the ACCESS lamp on the camera lights or blinks.
- If you are using a brand new SD card, you need to format it with the camera first. You may not be able to copy files from the SD card to the PC without doing so.
- The file extension may not appear depending on the [FOLDER] option setting of Windows®.

How to play back video files from the [EXTMOV] folder on the camera

On the index display of video files, press the recording start/stop button to display "MPG" on the screen. After that, follow the usual operation for playback. However, playlist functions are not available.

Copying Files to the PC (Windows®)

Still images and video files that are stored in a recording medium can be copied to the PC and played back on the PC.

1 Perform the procedure in “Viewing the Contents of a Recording Medium (Windows®)” (pg. 14).

The folders in the recording medium appear.

2 Create a new folder, enter the folder name, and then double-click it.

For example, create a new folder in the [My Pictures] folder.

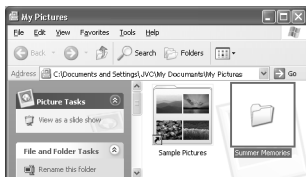

3 Select the folder to be copied, and then drag and drop that folder in the destination folder.

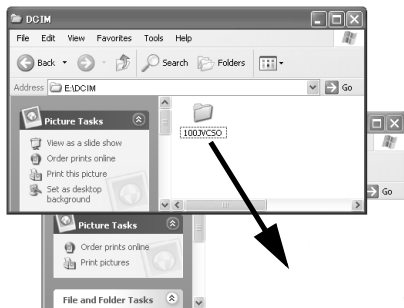

To copy still images: Copy the folder within the [DCIM] folder.

To copy video files: Copy the folder within the [SD_VIDEO] folder.

- The ACCESS lamp on the camera lights or blinks, and the folder is copied from the recording medium to the PC.

NOTES:

- Never disconnect the USB cable while the ACCESS lamp on the camera lights or blinks.
- File transfer takes considerable time in PCs. Usage of a PC that supports USB 2.0 is required.

Playing Back Files on the PC (Windows®)

Still images

Use an application that can handle the JPEG file format.

To view a still image, double-click the still image file (extension “.jpg”).

Video files

Use the PowerDVD 5 NE.

You can install this software from the provided CD-ROM. For more details of PowerDVD 5 NE, refer to “Playing Back Copied Video (Windows®)”. (pg. 20)

NOTE:

When playing back a file in the recording medium on your PC, copy the file to your PC, and then play it back. If video file is played back directly from recording medium (i.e. the camera is connected through USB to your PC), it may be not played back properly due to the inadequate processing speeds or other problems.

Disconnecting the USB cable (Windows®)

Before loading or unloading recording mediums or turning off the PC, first disconnect the USB cable and turn off the camera.

1 Confirm that the ACCESS lamp on the camera does not light or blink.

- If the ACCESS lamp lights or blinks, wait until it is turned off before proceeding.

2 Double-click the [Safely Remove Hardware] or [Unplug or Eject Hardware] icon in the status bar.



The [Safely Remove Hardware] or [Unplug or Eject Hardware] dialog box appears.

Windows® XP: If not, wait a while then go to step 5.

3 Select [USB Mass Storage Device] or [USB Disk], and then click [Stop].



4 Click [OK].

Windows® 2000: If a message indicating that the device can be safely removed appears, click [OK] and then click [Close].

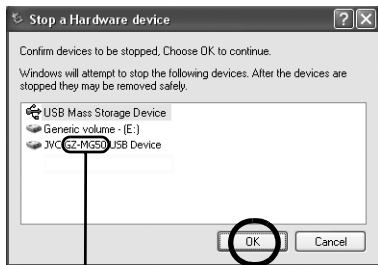

* The model name depends on the connected camera.

5 Disconnect the USB cable.

6 Set the camera's power switch to off.
The camera turns off.

User's Guide/Help/Readme (Windows®)

This manual only refers to software installation and PC connection. For more details of each software, refer to its User's Guide/Help/Readme.

■ CyberLink DVD Solution

Following steps are the example of CyberLink PowerDirector Express NE.

1 Click [Start], go to [All Programs] or [Programs]– [CyberLink PowerDirector Express], and then click User's Guide/Help/Readme depending on your preference.

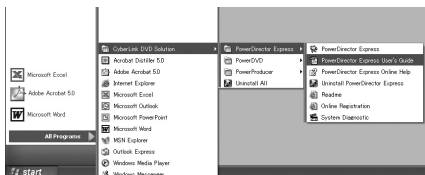

INFORMATION

The programs in CyberLink DVD Solution are versions with limited functionality. The User's Guide and Help files are written for the commercial version available in stores. For information about the differences with the commercial version, see the Readme file or the following web site: <http://www2.cli.co.jp/products/ne/> for the respective program.

■ Digital Photo Navigator

The User's Guide is included on the CD-ROM in PDF format. Right-click the CD-ROM icon in [My Computer], then click [Open]. Double-click the [Docs] folder, then double-click the [PhotoNavi] folder. Open the "Start.pdf" file and click the button of the desired language. Note that Adobe® Acrobat® Reader™ or Adobe® Reader® must be installed to read PDF files.

Adobe® Reader® can be loaded from Adobe's web site: <http://www.adobe.com/>

Backing Up Video files (Windows®)

- 1 Set the camera to playback mode.
- 2 Connect the camera to the PC with the USB cable.
- 3 The message [USB MASSSTORAGE] is displayed on the LCD screen.

When using Windows® XP:

Select [Open folders to view files using Windows Explorer] from the [Removable Disk] screen on the PC.



When using Windows® Me/2000
Select [Removable Disk] from the [My Computer] screen.



- 4 Create a new folder with a selected name on the desktop.

5 Copy the entire [SD_VIDEO] folder.
When returning folders backed up to the PC back to the camera, be sure to first erase the [SD_VIDEO] folder in the camera HDD before copying the [SD_VIDEO] folder of the PC.

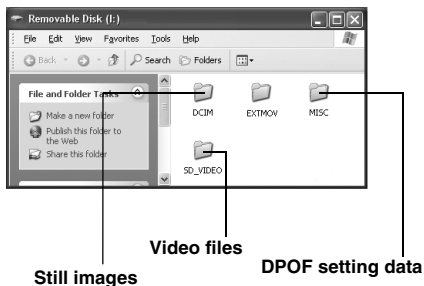

- The [EXTMOV] folder may contain dropped scenes or video corrupted by the management folder due to some cause. In this case, be sure to copy this entire folder too.

Playing Back Copied Video (Windows®)

Creating play lists using multiple files and viewing video

1 Click the bottom right of the operation panel to create a playlist using multiple files.



2 Click [File Mode].

The video files can be selected in folder units.

Viewing the video for a single file

Drag and drop a MOD file over the PowerDVD shortcut icon, PowerDVD 5 NE screen, or the operation panel.

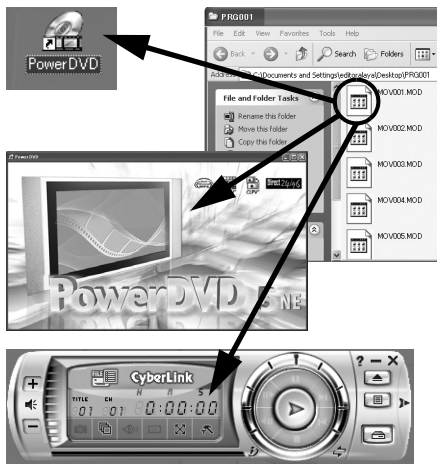

How To Create DVDs simply (Windows®)

1 Start PowerDirector Express NE and click [Load a media folder] of the import button, then select the folder that you have copied to PC to register it to the library.

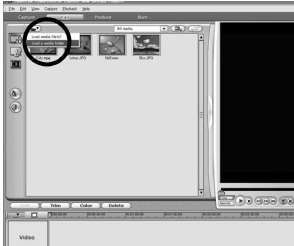

2 Drag and drop the videos from the library to the timeline/storyboard in the playback order.

- If necessary, edit transition or title on the timeline/storyboard. Click [Produce] button after finish editing.
- Video in 4:3 aspect ratio and 16:9 aspect ratio cannot be edited together.
- If a still image is inserted into video in 16:9 aspect ratio, the image must be squeeze processed first by using the Digital Photo Navigator.

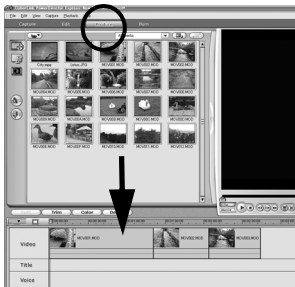

(Example of transition)



3 Select [Produce a Disc], and then click [Next].



4 Select [DVD Format] and click [Next].

- If the video is [ULTRA FINE], [FINE], or [NORMAL], select [High Quality NTSC (or PAL) DVD]. If the video is [ECONOMY], select [Long Play NTSC (or PAL) DVD]. Encoding is not performed on unedited video, and high-speed processing is performed at the original image quality.
- Insert a check mark for [Use SVRT to save rendering time]. The minimum required encoding is performed, and high-speed processing is performed while keeping the original image quality. Insert a check mark for [After production, make disc in PowerProducer].
- If the image is in 16:9 aspect ratio, insert a check mark for [Export 16:9 movie].

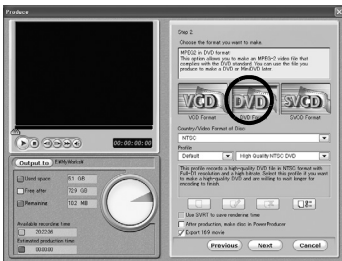

- Check that you do not exceed the recordable capacity of the DVD.

5 Click [Start] to create the file. After the completion of video file creation, PowerProducer 2 Gold NE starts automatically.

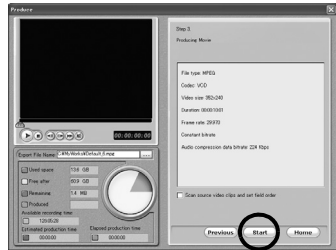

6 Load a blank DVD media into the recordable DVD drive.

- When you watch DVDs on commercially available DVD player, it is recommended to burn to DVD-R.

7 Click [→] in the [Import/Capture Content] screen of PowerProducer 2 Gold NE.



8 Remove the check mark for [Include Menu] in the [Preview] screen, and then click [→].



9 Insert a check mark for [Burn to disc] in the [Final Output] screen, and then click [→] to create the DVD-Video.

Check that you do not exceed the recordable capacity of the DVD

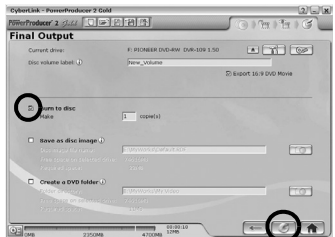

For more details for creating a DVDs, refer to the User's Guide of PowerDirector and PowerProducer installed on the PC.
(pg. 18)

Creating a DVD with Titles (Windows®)

1 Connect the camera to the PC with the USB cable, or remove the SD Memory Card from the camera and connect it to the PC using the card reader. Copy the video file folder (ex. "PRG001") in the recording medium to the PC.

"SD_VIDEO" folder

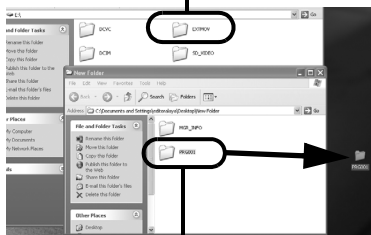

"PRG001" folder

2 Start PowerDirector Express NE and click [Load a media folder] of the import button, then select the folder copied to PC in step 1 to register it to the library.

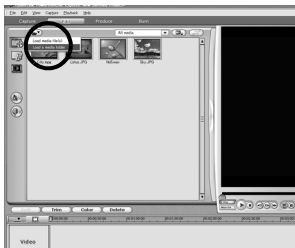

CONTINUED ON NEXT PAGE

3 Drag and drop the videos from the library to the timeline/storyboard in the playback order.

- If necessary, edit transition or title on the timeline/storyboard. Click [Produce] after finish editing.
- Video in 4:3 aspect ratio and 16:9 aspect ratio cannot be edited together.
- If a still image is inserted into video in 16:9 aspect ratio, the image must be squeeze processed first by using the Digital Photo Navigator.

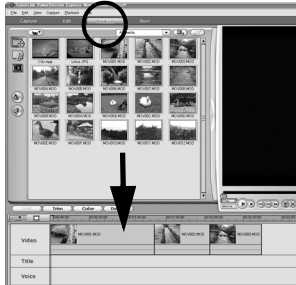

(Example of transition)



4 Select [Create a File (Everio Series)], and then select [Next].

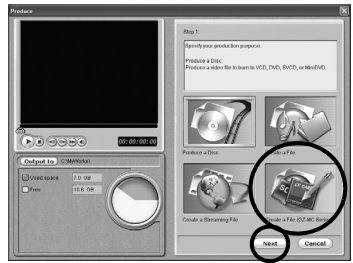

5 Select the same mode as the recording mode of the editing data, and then click [Next].

- If using a video file with an aspect ratio of 16:9, insert a check mark for [Export 16:9 movie] (Select [ULTRA] if the recording mode is unknown.) Note that a check mark cannot be inserted for DVD+VR.
- Insert a check mark for [Use SVRT to save rendering time]. The minimum required encoding is performed, and high-speed processing is performed while keeping the original image quality. Insert a check mark for [After production, make disc in PowerProducer].
- If the image is in 16:9 aspect ratio, insert a check mark for [Export 16:9 movie].

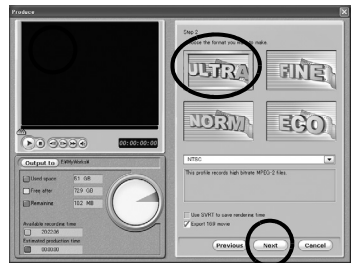

NOTE:

Check that you do not exceed the recordable capacity of the DVD.

6 Click [Start].

This starts conversion of the edited file. The file is saved to the location displayed in the storage location. Before creating slideshows or titles on a DVD that includes video in 16:9 aspect ratio, still images must first undergo the squeeze process.

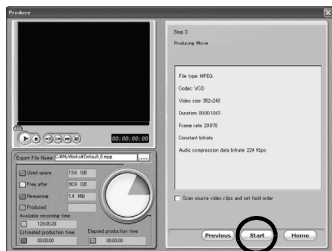

7 Click [Home].

8 Load an unrecorded DVD media into the DVD drive.

9 Start PowerProducer.

10 Select [DVD].

For the detail of the quality of the video, refer to the following table.

PowerDirector Express NE	PowerProducer 2 Gold NE
ULTRA FINE	HQ
FINE	XP
NORMAL	SP
ECONOMY	EP

11 Click [Open media files]. The file that was saved before is opened. Organize the files in the order they will be played by checking them using the Preview or other method.



12 Insert a check mark for [Include Menu].



• The menu screens, menu titles, and background music (BGM) can be changed. Use the additional functions to change as you like, and then click [→].

13 Insert a check mark for [Burn to Disc], and then click the [Burn] button to create the DVD video.

Software Installation (Macintosh)

Follow the procedure described below to install the software.

Before start installing, quit any other software you are using.

Capty MPEG Edit EX

This application is used to edit video files (MPEG-2 format) and write them into QuickTime and a variety of formats.

1 Load the provided CD-ROM into the PC. Double click the CD-ROM icon.

2 Double-click the [Capty MPEG Edit EX for Everio] folder in the CD-ROM.

3 Double-click the [Capty MPEG Edit EX.pkg] icon.



4 Click [Continue] when you asked to continue installing the software.

Introduction screen appears.



5 Click [Continue] on the Introduction screen.

Read Me screen appears.

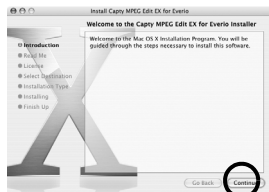

6 Read the Important Information carefully and click [Continue].

License screen appears.

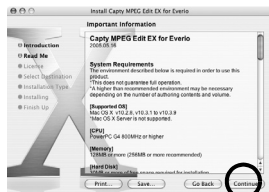

7 Read the Software License Agreement carefully and click [Continue].

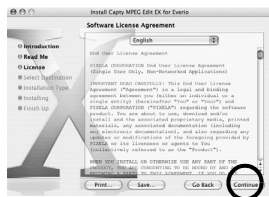

8 Click [Agree] if you agree with the license agreement.

Select a Destination screen appears.



9 Select the destination volume and click [Continue].

Installation Type screen appears.

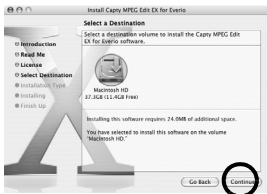

10 Click [Upgrade] if you perform a basic installation of the software.

Authenticate screen appears.

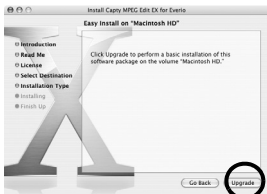

11 Enter the Macintosh Administrator name and password in [Name] and [Password] respectively, and click [OK].

Finish Up screen appears.



- If you are not the owner, this screen will not be appeared.

12 Click [Close] after you will confirm the message that tells you the installation has been completed.

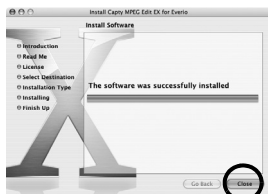

13 Click [Close] when the installation is finished and eject the CD-ROM.

Connections (Macintosh)

Connect the USB cable to copy still images and video files in a recording medium to the PC.

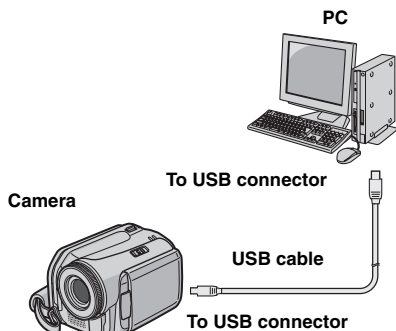

- 1** To assure safety, make sure all units are turned off before making any connections.
- 2** Use the USB cable to connect the camera to the PC.

NOTES:

- It is recommended to use the AC Adapter as the power supply instead of the battery pack.
- When the USB cable is connected, turning on or off the camera causes malfunctions of the PC.
- Connect the camera directly to the PC, not through the hub.
- Do not use an extension USB cable.

Viewing the Contents of a Recording Medium (Macintosh)

- 1** If you want to view the contents in the SD Memory Card, make sure that the card is set in the camera.
- 2** Set the camera's power switch to the playback mode while pressing down the lock button located on the switch.
- 3** Connect the camera to the PC with a USB cable. (▶ pg. 28)

On the camera's LCD monitor [USB MASSSTORAGE] appears. The recording medium icon appears on the desktop.



- The name of the recording medium icon is "Untitled", "Unlabeled" or "No name". We recommend that you name the icon to tell it from the other removable disks or folders
- If the SD card is in the camera, two "No name" icons appear. Check the contents in each recording medium.

4 Double-click the memory card icon on the desktop.

The folders in the recording medium appear.

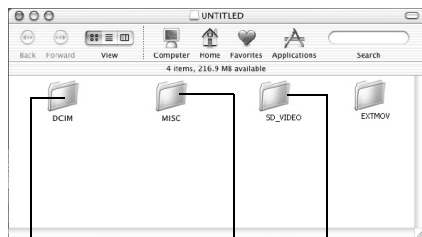

Still images

DPOF Setting data

Video files

Different file types are stored in different folders.

[DCIM]: Contains folders with still images
(extension “.jpg”)

[SD_VIDEO]: Contains folders with video
(MPEG2) files (extension “.mod”)

[EXTMOV]: Contains video (MPEG2) files that
failed to be produced by an accident
such as when dropped (extension
“.mod”)

[MISC]: Contains folders with DPOF setting
data

NOTES:

- Any folders or files other than those described above are also recorded in the recording medium.
- Saving the wrong kinds of files in a recording medium or deleting files or folders from a recording medium can cause problems with the operation of the camera. When it is necessary to delete a file from a recording medium, delete it through the camera. Also, do not move or rename folders and files within the medium on PC.
- Never disconnect the USB cable while the ACCESS lamp on the camera lights or blinks.
- If you are using a brand new SD card, you need to format it with the camera first. You may not be able to copy files from the SD cards to the PC without doing so.
- If the video file is not recorded or saved properly, the file is moved to [EXTMOV] folder with extension “.mod”.

Copying Files to the PC (Macintosh)

Still images and video files that are stored in recording medium can be copied to the PC and played back on the PC.

1 Double-click the recording medium icon on the desktop.

The folders in the recording medium appear.

2 Create a new folder, enter the folder name, and then double-click it.

3 Select the folder to be copied, and then drag and drop that folder in the destination folder.

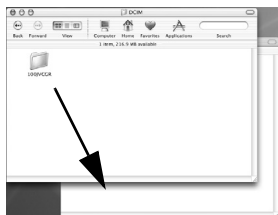

To copy still images: Copy the folder within the [DCIM] folder.

To copy video files: Copy the folder within the [SD_VIDEO] and [EXTMOV] folders.

- The ACCESS lamp on the camera lights or blinks, and the folder is copied from the recording medium to the PC.

NOTE:

Never disconnect the USB cable while the ACCESS lamp on the camera lights or blinks.

Disconnecting the USB cable (Macintosh)

Before loading or unloading recording medium or turning off the PC, first disconnect the USB cable and turn off the camera.

1 Drop the recording medium icon on the desktop into the [Trash] icon.

- If the confirmation message appears, click [OK].

2 Confirm that the ACCESS lamp on the camera does not light or blink.

- If the ACCESS lamp lights or blinks, wait until it is turned off before proceeding.

3 Disconnect the USB cable.

4 Set the camera's power switch to off.

The camera turns off.



Help/Readme (Macintosh)

This manual only refers to software installation and PC connection. For more details of the software, refer to its Help/Readme.

■ Captv MPEG Edit EX

1 Open the [Captv MPEG Edit EX for Everio] folder in the [Applications] folder.

2 Double-click the [Captv MPEG Edit EX for Everio] icon.

* You can drag and drop the selected video files into the icon.



Help

Select [Captv MPEG Edit EX Help] in the help menu. The usage is described.

ReadMe

The file is in the [ReadMe] folder. Support information and the limit are mentioned.



INFORMATION

For the exclusive URL for Everio, refer to PIXELA web site: <http://www.pixela.co.jp/oem/jvc/e/index.html>

File Combination (Macintosh)

Step 1 Start Captv MPEG Edit EX.

1 Double click the [Macintosh HD] icon.



Macintosh HD

2 Open the [Applications] folder.

3 Open the [Captv MPEG Edit EX for Everio] folder.



4 Double click the [Captv MPEG Edit EX for Everio] icon to start Captv MPEG Edit EX.



Step2 To combine two or more files, they need to first be linked in File Combination Mode. If the files will not be combined, proceed to Step 6.

To switch to File Combination Mode, from the Capty MPEG Edit EX menu,

1 Click [View].

2 Click [Combine Files].



* When switching from Trimming Mode to File Combination Mode, the data being edited will be lost. Be sure to save it beforehand if necessary.

Step3 Opening file

1 Click [File] from the Capty MPEG Edit EX menu bar.

2 Click [Add File].



3 Select the folder that was copied, and then select the video file (extension MOD). To select multiple video files at once, click to select the files while holding down the command key, [⌘].

4 Click [Open] to import the file.



5 The files are arranged in playback order in the File Combination Mode window.

6 After the files are arranged, click [Create] to create the file.

Clicking [Add] and selecting each file individually will arrange the files in that order.

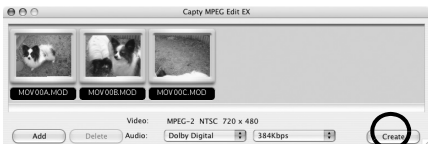

• Use the default audio setting of [Dolby Digital] and the bit rate. Change the bit rate according to the video quality.

Quality	Bit rate
ULTRA FINE	384Kbps
FINE	384Kbps
NORMAL	256Kbps
ECONOMY	128Kbps

Step4 Select the file format.

Normally, select MPEG (system stream) format. See Help for other file formats.

1 Select the file format, and click [Execute].

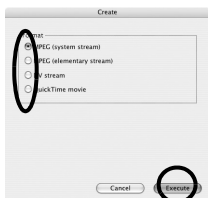

2 Enter the file name to be saved to [Save As].

3 Select the storage location under Where.

4 Click [Save] to save the file.

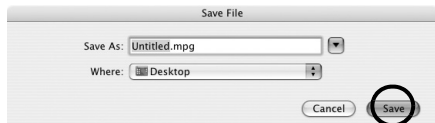

- To edit the combine file, reopen the file that was saved in [Trimming Mode], and then make the editing changes..

File Trimming (Macintosh)

Skip to Step9 if you do not edit video files.

Step5 Switching to Trimming Mode.

1 Click [View] from the Captivity MPEG Edit EX menu bar.

2 Click [Trimming].



- * When switching from File Combination Mode to Trimming Mode, the data being edited will be lost.

Step6 Opening file.

1 Click [File] from the Captivity MPEG Edit EX menu bar.

2 Click [Load File].

The [Select File] screen appears.

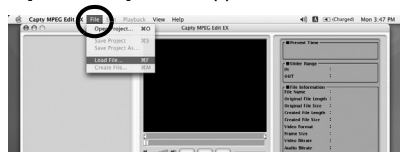

3 Select the video file (extension MOD or, MPG) and click [Open] to import the file.

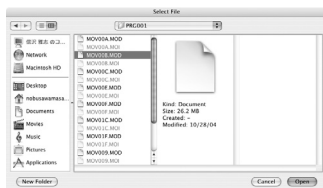

- Multiple videos cannot be selected at the same time. To combine multiple video files, start the procedure from Step2.

Step7 Editing

1 The point selected first in the trimming range is displayed in the GOP list or frame list. To edit in frame units, insert a check mark to display the frame in the frame list.

- Note that the scroll function will become slower.

2 Drag and drop the IN point in the trimming range (point selected first) from the displayed thumbnail to the IN Point preview box.

3 Drag and drop the OUT point (point selected last) in the trimming range from the displayed thumbnail to the OUT Point preview box.

4 When the selections in the range are completed, click [Set].

- If necessary, repeat operations to set the trimming range.

5 After editing is completed, click [Create].



- Click arrows on the screen while pressing down the shift key to set the Scroll Distance.
- For further details about the operations on the screen, refer to Help.

Step8 Saving

1 Select the trimming range processing method.

Delete trimming range

Deletes the trimming range and creates a new file.

Combine range and create

Combines the multiple trimming ranges that were set in the trimming list at the currently selected locations. A single file is created.

Create individual ranges

Individual files are created for each currently selected range.

2 Select the file format.

- When creating DVD video using PIXELA's "CaptyDVD/VCD Ver. 2", be sure to select MPEG (system stream) format.

3 Click [Execute] to create the file.

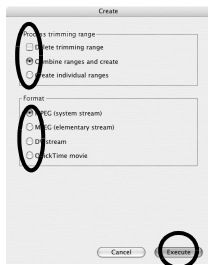

4 Name the file and click [Save].

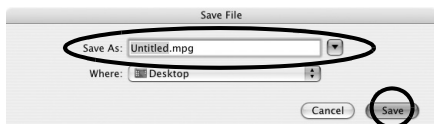

Step9 Creating DVDs

PIXELA's "CaptyDVD/VCD Ver. 2" is recommended for creating DVDs.

From CaptyDVD/VCD Ver. 2,

- There is no image quality degradation due to editing.
- Wide-screen video is supported.
- Video files in the Everio hard disk can be used without conversion.

For more information, refer to PIXELA web site:

<http://www.pixela.co.jp/oem/jvc/e/>

NOTES:

- MPEG files edited with the [Create a File (Everio Series)] command through the Windows version of CyberLink's PowerDirector Express NE (in Normal and Economy modes) cannot be imported.
- When multiple files selected simultaneously in File Combination mode are imported, they may not always be arranged in the recorded order or file name order. To arrange them in order, import them one file at a time.

EN

**SOFTWARE INSTALLATION
AND USB CONNECTION
GUIDE**

JVC

Read this first! **– How to handle the Hard Disk Camcorder –**

Please read this together with the instruction manual before using the camera.

■ **Make a backup of important recorded data**

Protect your important recorded data by copying the files to PC. It is recommended to copy it from your PC to a DVD or other recording media for storage. Refer to the software installation and USB connection guide.

■ **Make a trial run before recording important data**

Play back the recorded data to check that the video and sound have been recorded correctly.

■ **Check the compatible recording media**

The following SD cards have been guaranteed to work with this camera. Others are not guaranteed to work, so buy such products with caution.

SD Memory Cards: By Panasonic, TOSHIBA, pqi (still image only) and SanDisk

- If other media are used, they may fail to record data correctly, or they may lose data that has already been recorded.
- MultiMediaCards are not supported.
- For video recording, use a high-speed SD Memory Card (at least 10 MB/s).

■ **Format recording medium before using**

Before using this camera, use the Format function [FORMAT] in the menu to format the built-in hard disk or SD cards. Also, be sure to format the newly-purchased SD cards with this camera before using them. This enables stable speeds and operation when accessing the recording medium.

■ **Take care to hold the camera correctly during recording**

Do not cover the area near the lens, stereo microphone and camera sensor with your finger or any object while recording. Refer to "Index" of the instruction manual.

■ **When a certain length of time passes without operation**

- When using the battery, the power is turned off automatically to conserve power. Use the power switch to turn on the power again.
- When using the AC adapter, the access lamp lights up, and the LCD turns off (the camera enters the sleep mode). Operation is restored once any operation is made.

■ **When this camera is connected to PC with the USB cable**

- The recording media become read-only.
- To maintain high performance of a recording medium, it is recommended to perform check disks (error checks) using PC on a regular basis. Make sure that there is no data in the hard disk of the camera before running the check disk. Refer to the instruction manual of your PC for check disks.
- When you delete the files in the [EXTMOV] folder, perform on the PC by using commercially available SD Card Reader/Writer or format a recording medium on the camera.

■ **Reset the camera if it does not operate correctly**

This camera uses a microcomputer. Factors such as background noise and interference can prevent it from operating correctly. If the camera does not operate correctly, reset the camera. Refer to "Troubleshooting" of the instruction manual.

■ **If a problem occurs with the SD Memory Card, bring the card together with the camera**

When requesting repairs for breakdowns by your dealer or JVC service center, be sure to bring your camera together with the SD Memory Card. If one of them is not included, the cause cannot be diagnosed, and the repair cannot be made properly.

After reading this sheet, store it together with the instruction manual, and refer to it when necessary.